

# **Installation Guidelines**

**NWFA Information Available  
as of  
November 17, 2008**



# CONTENTS

## **SECTION I – GENERAL GUIDELINES**

---

CHAPTER 1	JOBSITE CONDITIONS
CHAPTER 2	ACCLIMATION
CHAPTER 3	MOISTURE REQUIREMENTS AND MOISTURE TESTING

## **SECTION II – SUBFLOOR GUIDELINES & SPECIFICATIONS**

---

CHAPTER 4	WOOD SUBFLOOR GUIDELINES
CHAPTER 5	CONCRETE SUBFLOOR GUIDELINES
CHAPTER 6	INSTALLING A SUBFLOOR OVER CONCRETE

## **SECTION III – INSTALLATION GUIDELINES & METHODS**

---

CHAPTER 7	PARQUET INSTALLATION
CHAPTER 8	ENGINEERED FLOORING INSTALLATION
CHAPTER 9	SOLID STRIP & PLANK INSTALLATION
CHAPTER 10	INSTALLING OVER AN EXISTING FLOOR

## **SECTION IV                      APPENDICES**

---

Appendix A	SAFETY GUIDELINES
Appendix B	ACCLIMATION
Appendix C	MOISTURE GUIDELINES & MOISTURE TESTING
Appendix D	MOISTURE BY AREA – US
Appendix E	MOISTURE BY AREA – CANADA
Appendix F	FASTENER SCHEDULE
Appendix G	TRAMMEL POINT METHOD
Appendix H	RADIANT HEAT INSTALLATIONS
Appendix I	INSTALLATION OVER SCREEDS
Appendix J	SOUND CONTROL
Appendix K	TRIM & THRESHOLDS
Appendix L	SAMPLE SPECIFICATION
Appendix M	JOBSITE CHECKLIST

## **SECTION V                      GLOSSARY**

---

GLOSSARY OF WOOD FLOORING TERMS
---------------------------------



# SECTION I

## GENERAL GUIDELINES

CHAPTER 1	JOB SITE CONDITIONS.....	Page 1
CHAPTER 2	ACCLIMATION .....	Page 5
CHAPTER 3	MOISTURE REQUIREMENTS AND MOISTURE TESTING .....	Page 7

# CHAPTER 1

## JOBSITE CONDITIONS

### Part I – Minimum Jobsite Requirements

- A. Wood flooring should be one of the last jobs completed on the construction project. Limit foot traffic on finished wood flooring.
- B. Evaluate the jobsite for potential problems before installation begins, and before wood flooring is delivered to the jobsite.
- C. Unless a waiver or letter of protest listing exceptions exists, installation constitutes acceptance of subfloor/substrate, the jobsite itself – including the ambient temperature and relative humidity at the time of installation, and all impacting variables that may affect a wood floor.
  - 1. Surface drainage should direct water away from the building.
  - 2. Do not deliver wood flooring to the jobsite or install wood flooring until the building is enclosed.
  - 3. If heating and/or air-conditioning is in operating condition, it needs to be operating. If it is not possible for the permanent heating and/or air-conditioning system to be operating before, during and after installation, a temporary heating and/or dehumidification system that mimics normal temperature and humidity conditions can enable the installation to proceed until the permanent heating and/or air-conditioning system is operating.
  - 4. Do not deliver wood flooring to the jobsite or install wood flooring until appropriate temperature and humidity conditions have been achieved. Appropriate temperature and humidity conditions are defined as those conditions to be experienced in the building after occupancy.
  - 5. Do not deliver wood flooring to the jobsite or install wood flooring until all concrete, masonry, plastering, drywall, texturing and painting primer coats are completed.
  - 6. Basements and crawl spaces must be dry. If power washing is required in the basement, do so before wood flooring is installed and allow subfloor and basement to dry before installing wood flooring.
  - 7. Crawl space should be a minimum of 18” (457mm) from ground to underside of joists.
  - 8. Crawl space earth (or thin concrete slab) should be covered 100 percent by a vapor retarder of black polyethylene (minimum 6 mil) or any recommended puncture-resistant membrane, such as Class C, meeting ASTM D-1745. See Figure 1-1.

9. Crawl Space Conditions

- a. Where a proper ground covering is in place and when venting is required by local building codes, the crawl space should have perimeter venting equal to a minimum of 1.5 square feet per 100 square feet of crawl space square footage, unless local building codes differ from this specification. Note:

Local-building codes may differ. Follow local building codes.

- b. For crawl spaces without ventilation openings, vapor retarder joints must overlap a minimum of 6 inches and be sealed or taped. The vapor retarder should also extend at least 6 inches up the stem wall and be attached and sealed to the stem wall. Continuously operated mechanical exhaust and perimeter wall insulation or conditioned air supply and insulation must be provided.

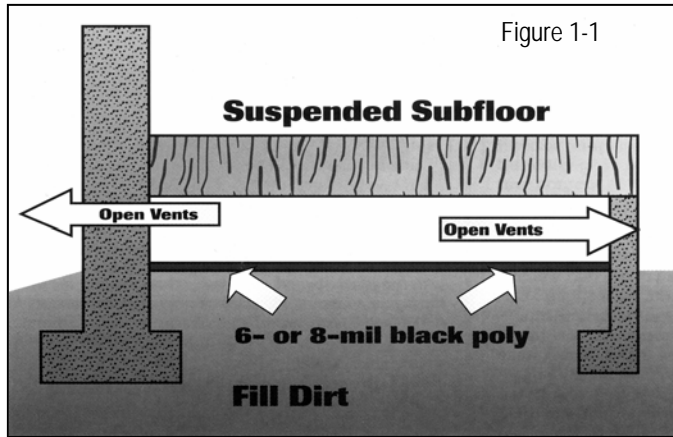

10. Note the grade level so that the correct type of flooring and system can be specified for the job. Engineered and floating floors can be appropriate for above-grade, on-grade and below-grade installations. Solid wood flooring can be appropriate for above-grade and on-grade installations, but not for below-grade installations. If the soil surrounding a structure is 3 inches or more above the floor of any level, consider that level below grade. This includes walk-out basements. In addition, the surrounding soil should be sloped away from the structure. See Figure 1-2.

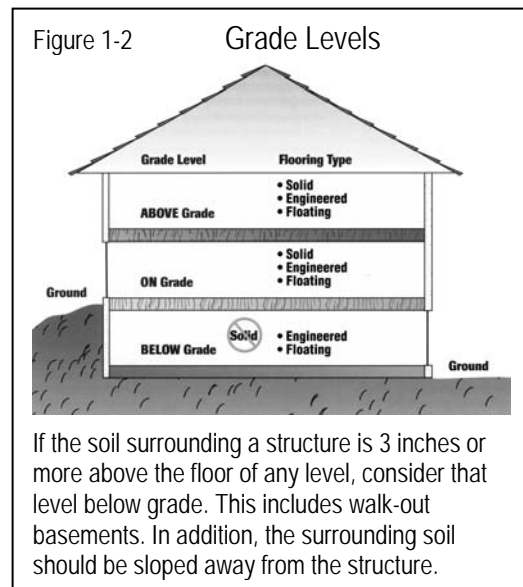

11. Subfloors (wood or concrete) should be checked by an appropriate method for establishing moisture content. Average subfloor moisture content should be within the range as specified for the product by the product manufacturer. See Chapter 3, Moisture Testing.

12. Where the minimum jobsite conditions are present, the flooring can be delivered and stored in the rooms in which it will be installed. See Chapter 2, Acclimation.

## Part II - Additional Jobsite Conditions for Factory-Finished Flooring

- A. All finished wall coverings and painting should be completed. Note: Base and shoe mold may be installed and finished after the flooring installation.
- B. After installation, if you choose to protectively cover the floor, cover the floor completely, since some species are light-sensitive and uncovered areas may change color. However, covering a glue-down application may not allow some adhesives to properly cure. Follow the flooring and adhesive manufacturer's recommendations. Use a covering material with a vapor permeance (perm rating) of 1 perm or more (tested in accordance with ASTM E-96) to avoid trapping moisture/vapor on or within the floor. A common reinforced builder's paper is a good choice. Any covering should be taped, using a low-adhesion tape, to base or shoe moldings. Avoid taping to finished flooring. When taping paper or sheets together, tape them to each other, not to the floor.

## Part III – Jobsite Checklist

**See Appendix M**

# CHAPTER 2

## ACCLIMATION

ALWAYS FOLLOW THE MANUFACTURERS' RECOMMENDATIONS REGARDING HOW AND WHETHER TO ACCLIMATE WOOD FLOORING.

### Part I – General Acclimation Guidelines

**(For a more detailed discussion of acclimation issues, See Appendix B.)**

#### A. Storage and Conditions

1. Do not store wood flooring at the jobsite under uncontrolled climate conditions. Garages and exterior patios, for example, are not acceptable areas to store wood flooring.
2. Ideal interior climate conditions vary from region to region and jobsite to jobsite. It is your responsibility to know what your “ideal” climate conditions are and build your floor around those conditions. For a general view of moisture-content averages by region, refer to Appendix D and Appendix E.

#### B. Acclimation

**Note: Some manufacturers do not require acclimation for certain products prior to installation. If the manufacturer recommends that the wood flooring be acclimated before installation, proceed as follows:**

1. Ensure that the building is enclosed.
2. Verify that the building is maintained at normal living conditions for temperature and humidity.
3. Where building codes allow, permanent heating and/or air-conditioning systems should be operating at least five days preceding installation to promote proper acclimation. For radiant heat see Appendix H.
4. If it is not possible for the permanent heating and/or air-conditioning system to be operating before, during and after installation, a temporary heating and/or dehumidification system that mimics normal temperature and humidity conditions can enable the installation to proceed until the permanent heating and/or air-conditioning system is operating.
5. Upon delivery, check wood flooring moisture content with a moisture meter to establish a baseline for required acclimation. Check the moisture content of multiple boards. A good representative sample is typically 40 boards for every 1,000 square feet of flooring. Acclimate to manufacturer's recommendations or as necessary according to geographical location and your jobsite location.



6. Prior to installation, ensure that wood flooring is within acceptable range of moisture content with the wood subfloor. For solid strip flooring (less than 3" wide), there should be no more than 4 percent moisture content difference between properly acclimated wood flooring and subflooring materials. For wide-width solid flooring (3" or wider), there should be no more than 2 percent difference in moisture content between properly acclimated wood flooring and subflooring materials.



# CHAPTER 3

## MOISTURE TESTING

### Part I - Moisture Testing for Wood Subfloors

#### A. Testing Requirements

1. Test for moisture at several locations in the room — a minimum of 20 per 1,000 square feet — and average the results. A high reading in one area indicates a problem that must be corrected. Pay special attention to exterior and plumbing walls

### Part II - Acceptable Vapor Retarders Over Wood Subfloors

#### **A. ALWAYS FOLLOW LOCAL CODES AND MANUFACTURERS INSTRUCTIONS FOR ACCEPTABLE VAPOR RETARDERS.**

- B. An acceptable vapor retarder is a vapor resistant material, membrane or covering with a vapor permeance (perm rating) of greater than or equal to .7 and less than or equal to 50 when tested in accordance with ASTM E-96 Method A. Installation of a vapor retarder reduces the potential for moisture or vapor related problems, but does not guarantee elimination of moisture or vapor related problems. Install a vapor retarder over wood panel or board sub-floors prior to installing nail down solid strip or plank flooring. Over-lap seams a minimum of 4 inches or more as required by manufacturer or specifier and local building codes.

#### C. Some examples of acceptable vapor retarders over wood subfloors include:

1. An asphalt laminated paper meeting UU-B-790a, Grade B, Type I, Style 1a.
2. Asphalt-saturated kraft paper or #15 or #30 felt paper meeting ASTM Standard D-4869 or UU-B-790, Grade D.

#### D. NOTE:

1. A vapor retarder has some extra benefits in that it eliminates wood-on-wood contact, wood strips slide more easily when positioned, minimizes the impact of seasonal humidity change and may reduce dust and noise levels.
2. However, by today's standards, asphalt saturated kraft or felt paper may not be an effective vapor retarder in all applications. The 2006 International Residential Code requires a vapor retarder on the warm-in-winter side of exterior floors (a floor over a vented crawl space, for example), with a vapor permeance of 1 perm or less in Zones 5 and higher.
3. Over a wood subfloor, do not use an impermeable vapor retarder material with a perm rating of .7 or less, such as 6 mil polyethylene film or other polymer materials, as it may trap moisture on or in the wood subfloor.
4. Do not use common red rosin or building paper which is not asphalt saturated. They are not vapor retarders as their perm rating is far greater than 50.

## **Part III - Moisture Testing for Concrete Slabs**

**NOTE: All tests give a result – at the time the test is done. And in general give you the ability to start or not start a job – these tests do not give a permanent condition of your substrate merely a “at the time the test was performed” indication.**

### A. Testing Requirements

1. Before moisture testing begins, the concrete slab must be a **MINIMUM** of 30 days old.

### B. Qualitative Moisture Tests

1. Electrical Impedance Test and Electrical Resistance Test (Moisture Meter)

#### **Follow meter manufacturer’s instructions.**

- a. Use moisture meters designed specifically for concrete moisture testing.
- b. Test within the body of the slab (electrical resistance), as well as at the surface (electrical impedance).
- c. These testing methods are not recognized by any standard and should not be used for the purpose of accepting or rejecting a floor. These electronic tests are useful survey tools to broadly evaluate the relative moisture conditions of a slab and to select locations for quantitative moisture tests.
- d. If the moisture meters indicate the presence of excessive moisture, as per wood flooring or meter manufacturer’s recommendations, further testing is required using relative-humidity testing (ASTM F-2170), calcium chloride testing (ASTM F-1869) or calcium carbide (CM) testing (ASTM D-4944-04 and MilSpec CRD-C154-77).

2. Phenolphthalein Test

- a. Perform one test per 200 square feet of surface area, with a minimum of two tests per jobsite.
- b. Chip a small section of concrete off the floor and apply 3 percent phenolphthalein in alcohol solution (available at most druggists) in the area. A red color indicates that moisture is present. Always chip the concrete as this protects against the possibility that a concrete sealer was applied.

**IMPORTANT: Keep phenolphthalein out of direct sunlight. The average shelf life of phenolphthalein is six months.**

- c. If the phenolphthalein test indicates the presence of excessive moisture, further testing is required using relative-humidity testing (ASTM F-2170), calcium chloride testing (ASTM F-1869) or calcium carbide (CM) testing (ASTM D-4944-04 and MilSpec CRD-C154-77).

### C. Quantitative Moisture Tests

1. Relative Humidity Testing – ASTM F-2170 (Standard Test Method for Determining Relative Humidity in Concrete Floor Slabs Using In Situ Probes)

- a. Select test locations to provide information about moisture distribution across the entire concrete floor slab. For slabs on grade and below grade, include a test location within three feet of each exterior wall.
  - b. Perform three tests for the first 1,000 sq ft and one test for every additional 1,000 sq ft thereafter.
  - c. At least 48 hours before test is placed, concrete floor slabs should be at the same temperature and humidity that is expected during service conditions.
  - d. Use a rotary hammer-drill to drill holes in the concrete slab; 40% depth of slab is required for the holes when concrete is drying from one side and 20% when drying from both sides. **Follow manufacturer's instructions provided with test kits.**
  - e. Allow 72 hours to achieve moisture equilibrium within the hole before making relative humidity measurements.
  - f. ASTM F-710 provides installation guidelines for acceptance of hardwood flooring using relative-humidity testing. Typical limits for wood and wood-based products are 75% relative humidity. When getting readings over 75%, you must use a proper vapor retarder, based on the flooring manufacturer's recommendations, or wait for further concrete curing.
2. Calcium Chloride Test – ASTM F-1869 (Test Method for Measuring Moisture Vapor Emission Rate of Concrete Subfloor Using Anhydrous Calcium Chloride)
- a. Select test locations to provide information about moisture distribution across the entire concrete floor slab.
  - b. Perform three tests per 1,000 square feet of surface area. Add one additional test for each 1000 square feet thereafter.
  - c. At least 48 hours before test is placed, concrete floor slabs should be at the same temperature and humidity expected during service conditions
  - d. The actual test area shall be clean and free of all foreign substances. Use approved OSHA work practices for removal of all existing flooring materials and debris.
  - e. Blast or grind a minimum area of 20 inches by 20 inches and let stand for a minimum period of 24 hours prior to setting test.
  - f. Follow manufacturer's instructions for properly placing tests onto concrete.
  - g. Tests are to be covered and left in place for 60 to 72 hours. Follow manufacturer's instructions for labeling and recording time and date of test.
  - h. Send the test to a certified laboratory for results and documentation, or perform the measurements as per ASTM F-1869.
  - i. Always following the flooring manufacturer's guidelines and specifications to determine when the concrete slab is ready for installation.
  - j. ASTM F-710 provides installation guidelines for acceptance of hardwood flooring using calcium-chloride testing. Typical limits for direct glue-down wood flooring is 3lbs/1000sf/24hr. When getting readings over 3 lbs and up to 7 lbs, you must use a vapor retarder. A reading over 7 lbs may not be acceptable for wood flooring installation. Follow the wood flooring manufacturer's recommendations. In the case

of a glue-down installation, the adhesive manufacturer may also have recommendations.

NOTE: For information on the tests listed above, contact your distributor or call NWFA at 800-422-4556 U.S. or 800-848-8824 Canada for the source nearest you.

3. Calcium Carbide (CM) Test – ASTM (modified) D-4944-04, MilSpec CRD-C154-77
  - a. The calcium carbide test, also known as the CM test or calcium carbide bomb, is more widely used in Europe than in the United States. It is a gas-pressure test in which moisture in the concrete reacts with calcium carbide crystals to create acetylene gas, and the gas pressure produced is measured to provide a moisture content reading, expressed as a percentage of moisture. Follow the directions provided by the test-kit manufacturer. A reading of over 2.5% requires use of a vapor retarder. A reading over 4% may not be acceptable for wood flooring installation. Follow the wood flooring manufacturer's recommendations. In the case of a glue-down installation, the adhesive manufacturer may also have recommendations.

## **Part IV - Acceptable Vapor Retarders Over Concrete**

### **A. ALWAYS FOLLOW LOCAL CODES AND MANUFACTURERS INSTRUCTIONS FOR ACCEPTABLE VAPOR RETARDERS.**

- B. Test concrete for moisture. For concrete slabs with a calcium chloride reading of greater than 3 lbs, a relative humidity reading of greater than 75%, or a calcium carbide (CM) rating of greater than 2.5%, install an impermeable vapor retarder with a perm rating of less than .15 perm. Adding a vapor retarder is not required on installations over slabs with a calcium chloride reading of 3 lbs or less, a humidity reading of 75% or less, or a calcium carbide (CM) rating of 2.5% or less. However, in on-grade and below grade applications, adding a vapor retarder is always recommended.
- C. The 2006 International Residential Code defines a vapor retarder as a vapor-resistant material, membrane or covering such as foil, plastic sheeting or other material recommended by the manufacturer having a permeance rating of 1 perm or less, when tested in accordance with ASTM E-96 Method A.
- D. The NWFA recommends an "impermeable" vapor retarder with a perm rating of less than or equal to .15, thereby limiting the passage of moisture to near zero.
- E. Some acceptable vapor retarders over concrete include:
  1. A minimum 6 mil construction grade polyethylene film, with perm of .13, or other impermeable material with a perm of .15 or less is recommended. An premium polymer material meeting ASTM D-1745 for concrete with higher tensile, tear and puncture resistance is highly desirable.
  2. Double felt: Two layers of #15 asphalt saturated felt paper that meets ASTM Standard D-4869, with the first layer adhered to the slab in a skim coat of appropriate adhesive, and a second layer adhered to the first layer with appropriate adhesive.

3. A chemical retarder or urethane membrane, as recommended by the adhesive or wood flooring manufacturer. These are usually in the form of a liquid-applied or trowel-applied membrane dispensed from a bucket following manufacturer recommendations.



# SECTION II

## SUBFLOOR GUIDELINES & SPECIFICATIONS

CHAPTER 4	WOOD SUBFLOOR GUIDELINES .....	Page 1
CHAPTER 5	CONCRETE SUBFLOOR GUIDELINES.....	Page 5
CHAPTER 6	INSTALLING A SUBFLOOR OVER CONCRETE .....	Page 7

# CHAPTER 4

## WOOD SUBFLOOR GUIDELINES

**NOTE: Always follow the wood flooring manufacturer's recommendation for a proper subfloor.**

### Part I – Wood Subfloor Specifications

- A. Subfloor panels should conform to should conform to U.S. Voluntary Product Standard PS1-95, Construction and Industrial Plywood and/or US Voluntary PS 2-04 and/or Canadian performance standard CAN/CSA 0325.0-92 Construction Sheathing. Other CSA standards also apply.
- B. Solid-board subflooring should be  $\frac{3}{4}$ " x  $5\frac{1}{2}$ " (1" x 6" nominal), Group 1 dense softwoods, No. 2 Common, kiln-dried to less than 15 percent moisture content.
- C. Both CD EXPOSURE 1 plywood and OSB Exposure 1 subfloor panels are appropriate subflooring materials, but the proper thickness of the material will be determined by the factors noted below in **Part IV – Panel Products Subflooring, E - Acceptable Panel Subfloors.**

### Part II – Subfloor Moisture

**Note: the National Association of Home Builders' Green Home Building Guidelines contains the following directive under Section 5.3.8: "NAB Model Green Home Building Guidelines, Section 5.3.8: "Check moisture content of wood flooring before enclosing on both sides. Ensure moisture content of subfloor/substrate meets the appropriate industry standard for the finish flooring material to be installed."**

- A. For solid strip flooring (less than 3" wide), there should be no more than 4 percent moisture content difference between properly acclimated wood flooring and subflooring materials.
- B. For wide-width solid flooring (3" or wider), there should be no more than 2 percent difference in moisture content between properly acclimated wood flooring and subflooring materials.

### Part III – Subfloor Flatness and Integrity

- A. Wood subfloors must be flat, clean, dry, structurally sound, free of squeaks and free of protruding fasteners.
  - 1. For installations using mechanical fasteners of  $1\frac{1}{2}$ " and longer, the subfloor should be flat to within  $\frac{1}{4}$ " in 10 feet or  $\frac{3}{16}$ " in 6 feet.
  - 2. For glue-down installations and installations using mechanical fasteners of less than  $1\frac{1}{2}$ ", the subfloor should be flat to within  $\frac{3}{16}$ " in 10 feet or  $\frac{1}{8}$ " in 6 feet.
- B. If peaks or valleys in the subfloor exceed the tolerances specified above, sand down the high spots and fill the low spots with a leveling compound or other material approved for use under wood flooring. However, it is the builder's or general contractor's responsibility to

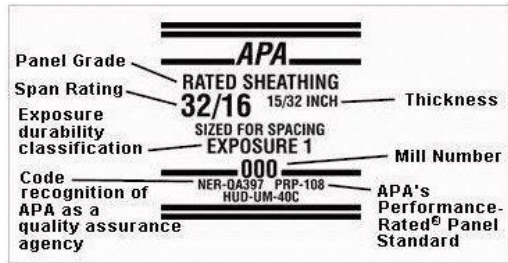

Image courtesy of Georgia Pacific - www.gp.com

When possible, check the back of the subfloor panel for American Plywood Association (APA) rating.

provide the wood-flooring contractor with a subfloor that is within the tolerances listed above.

- C. Inspect the subfloor carefully. If there is movement or squeaks in the subfloor, refasten the subfloor to the joists in problem areas.
- D. Protruding fasteners are easily remedied by driving those fasteners deeper into the subfloor.

## **Part IV - Panel Products Subflooring**

- A. For panel products subflooring, check for loose panels and re-nail or screw down loose panels securely.
- B. Ensure that there is proper expansion space (1/8") between the panels. If the subfloor panels are not tongue-and-grooved and if there is not sufficient expansion space, use a circular saw to create the specified space. Do not saw through joints on T&G subfloors.
- C. Also check for delaminated or damaged areas and repair those areas as needed.
- D. Make sure the subfloor is free of debris before beginning installation.
- E. Acceptable Panel Subfloors: Truss/joist spacing will determine the minimum acceptable thickness of the panel subflooring.
  1. On truss/joist spacing of 16" (406mm) o/c or less, the industry standard for single-panel subflooring is nominal 5/8" (19/32", 15.1mm) CD Exposure 1 Plywood subfloor panels (CD EXPOSURE 1) or 23/32 OSB Exposure 1 subfloor panels, 4' X 8' sheets.
  2. On truss/joist spacing of more than 16", up to 19.2" (488mm) o/c, the standard is nominal 3/4" (23/32", 18.3mm) T&G CD EXPOSURE 1 Plywood subfloor panels, (Exposure 1), 4' X 8' sheets, glued and mechanically fastened, or nominal 3/4" (23/32", 18.3mm) OSB Exposure 1 subfloor panels, 4' x 8' sheets, glued and mechanically fastened.
  3. Truss/joist systems spaced over more than 19.2" (488mm) o/c up to a maximum of 24" (610mm) require nominal 7/8" T&G CD EXPOSURE 1 Plywood subfloor panels, (Exposure 1), 4' X 8' sheets, glued and mechanically fastened, or nominal 1" OSB Exposure 1 subfloor panels, 4' x 8' sheets, glued and mechanically fastened — or two layers of subflooring. Or brace between truss/joists in accordance with the truss/joist



manufacturer's recommendations and with local building codes. Some truss/joist systems cannot be cross-braced and still maintain stability.

- a. For double-layer subfloors, the first layer should consist of nominal  $\frac{3}{4}$ " ( $\frac{23}{32}$ " , 18.3mm) CD Exposure 1 Plywood subfloor panels (CDX), 4' X 8' sheets or nominal  $\frac{3}{4}$ " ( $\frac{23}{32}$ " , 18.3mm) OSB Exposure 1 subfloor panels, 4' x 8' sheets. The second layer should consist of nominal  $\frac{1}{2}$ " ( $\frac{15}{32}$ " , 11.9mm) CD EXPOSURE 1 plywood subfloor panels, (Exposure 1) 4' X 8' sheets. The  $\frac{1}{2}$ " plywood should be offset by  $\frac{1}{2}$  panel in each direction to the existing subflooring. The panels may also be laid on a diagonal or perpendicular, with  $\frac{1}{8}$ " spacing between sheets. Nail on a 12" minimum grid pattern, using a ring-shanked nails or staples.

#### F. Fastening and Spacing Specifications

1. Follow the panel manufacturer's recommendations for spacing and fastening.
2. Typical panel spacing and fastening requirements for truss/joist systems call for approximately  $\frac{1}{8}$ " (3.2mm) expansion space around the perimeter of each panel, with panels fastened every 12" (305 mm) along intermediate supports.
3. Edge swell should also be flattened. This can usually be accomplished by using an edger sander.

### **Part V – Solid Board Subflooring**

- A. Solid board subflooring should be:  $\frac{3}{4}$ " x  $5\frac{1}{2}$ " (1x6 nominal), Group 1 dense softwoods (SYP, Doug Fir, Larch, etc.), No. 2 Common, kiln-dried to less than 15% MC.
- B. Solid-board subflooring should consist of boards no wider than 6 inches, installed on a 45 degree angle, with all board ends full bearing on the joists and fastened with minimum 8d rosin-coated or ring-shanked nails, or equivalent.
- C. Some types of wood flooring should not be installed directly over solid-board subflooring.
  1. Thin-classification solid strip flooring must have a  $\frac{3}{8}$ " or better plywood underlayment installed over solid board subflooring.
  2. Parquet flooring cannot be installed directly to solid-board subfloors. A parquet installation over solid-board subflooring requires  $\frac{3}{8}$ " or better underlayment panels, nailed on 6" minimum grid pattern using ring-shanked nails or staples.
- D. Some engineered flooring cannot be installed directly to solid-board subfloors. (See wood flooring manufacturer's recommendations.)

# CHAPTER 5

## CONCRETE SUBFLOOR GUIDELINES

**NOTE: Always follow the wood flooring and adhesive manufacturer's recommendation for a proper subfloor.**

### Part I – Concrete Subfloor Specifications

#### A. Subfloor Must Be Flat

1. Make sure the concrete slab is flat to the wood flooring manufacturer's specification. Typically, manufacturers will specify a flatness tolerance of 1/8" to 3/16" in a 10-foot radius.
2. If the slab is out of specification, consider grinding, floating or both. Many high spots can be removed by grinding, depressions can be filled with approved patching compounds, and slabs also can be flattened using a self-leveling concrete product.
3. When sanding or grinding concrete, care must be taken to minimize the amount of silica dust produced. OSHA recommends using dust-collection devices, or applying water to the concrete before sanding. Approved respirators may also be used to minimize the amount of silica dust inhaled.

#### B. Subfloor Must Be Dry

1. Refer Chapter 3, Moisture Requirements and Moisture Testing.
2. Concrete moisture meters and other tests can be useful in identifying moisture problem areas. However, NWFA guidelines specify using relative-humidity testing (ASTM F-2170), calcium chloride testing (ASTM F-1869) or calcium carbide (CM) testing (ASTM D-4944-04 and MilSpec CRD-C154-77) to identify the moisture content of the slab. See Chapter 3 and Appendix C.
3. If a slab tests too high in vapor emission to glue a floor down, consider using a vapor retarder type product, installing a vapor retarder and a plywood sub-floor or using an alternative installation method.
4. Concrete slabs with a calcium chloride reading of more than 3 require use a vapor retarder with a perm rating of 1 or less. It is strongly recommended to use an impermeable vapor retarder with a perm rating of .13 or less, such as 6 mil polyethylene film.

#### C. Slab Must Be:

1. Minimum 3000 psi
2. Free from non-compatible sealers, waxes, and oil, paint, drywall compound etc.
  - a. Check for the presence of sealers by applying drops of water to the slab, if the water beads up, there may be sealers or oils.

D. Do not attempt to glue a wood floor over a chalky or soft concrete slab.

E. Burnished, slick steel-troweled slabs may require screening with a 30-grit abrasive.

#### F. Specifications for Lightweight Concrete

1. Make sure the concrete is well bonded to the sub-floor. Check for hollow spots, cracks and loose areas.
2. As with on-grade concrete sub-floors make sure the concrete is clean, flat to specification and dry.
3. Over lightweight concrete (less than 3000 psi), if the flooring adhesive used has a higher shear strength than the concrete, use the **Floated Subfloor** installation method. (See Chapter 6.) If the psi of the concrete is unknown, use the **Floated Subfloor** installation method or contact the adhesive manufacturer.
4. Rule of thumb: Draw a nail across the top; if it leaves an indentation, it is probably lightweight concrete.

# CHAPTER 6

## INSTALLING A SUBFLOOR OVER CONCRETE

**NOTE: Always follow the manufacturer's recommendation for a proper subfloor.**

### **Part I – Direct Gluing a Subfloor Over Concrete**

- A. Always follow the adhesive manufacturer's recommendation for proper application, proper adhesive and correct trowel notch and spread rate.
- B. If necessary, add vapor retarder recommended by the adhesive manufacturer before applying adhesive.

### **Part II - Floated Subfloor**

- A. In on-grade and below-grade applications, always add vapor retarder before applying underlayment.
- B. In above-grade applications, follow the flooring manufacturer's recommendations.
- C. A vapor retarder is recommended anytime solid  $\frac{3}{4}$ " wood flooring is installed over concrete. A vapor retarder is required for installation over concrete with a calcium chloride reading greater than 3 pounds, a relative humidity reading of greater than 75%, or a calcium carbide (CM) reading of greater than 2.5%.
- D. Floated Subfloor System
  - 1. Materials
    - a. 2 layers nominal  $\frac{3}{8}$ " (10mm) minimum CD Exposure 1 Plywood subfloor panels (CDX) 4' X 8' sheets.
  - 2. Installation method:
    - a. Place the first plywood layer with edges parallel to wall, without fastening. Leave  $\frac{3}{4}$ " space between wall and plywood.
    - b. Plywood panels should be placed with  $\frac{1}{8}$ " gaps between sheets.
    - c. Lay the second layer perpendicular or at 45 degree angle to the first.
    - d. Plywood panels should be placed with  $\frac{1}{8}$ " gaps between sheets and a  $\frac{3}{4}$ " minimum expansion space at all vertical obstructions and wall lines.
    - e. Staple or staple and glue (with urethane or construction adhesive) the second layer to first layer on 12" interior grid pattern (6" on the perimeter). Be careful not to penetrate the vapor retarder.
- E. Alternate Subfloor System
  - 1. Materials
    - a. Use nominal  $\frac{3}{4}$ " (23/32", 18.3mm) CD Exposure 1 Plywood sheathing, 4'x8' sheets.
  - 2. Installation method

- a. Cut sheets to 16"X8' or smaller panels, scored on back 3/8" deep a minimum of every 12" across width.
- b. 16" planks oriented perpendicular or diagonally to direction of flooring
- c. Panels staggered every 2', and spaced 1/8" between ends, with 3/4" minimum expansion space at all vertical obstructions.

### **Part III - Glue-Down Subfloor**

- A. Always follow the adhesive manufacturer's recommendation for proper subfloor, spread rate and trowel notch.
- B. If necessary, add vapor retarder before applying underlayment. A vapor retarder is recommended anytime solid 3/4" wood flooring is installed over concrete.
- C. Glue-Down Subfloor System:
  1. Materials
    - a. Use nominal 5/8" (<sup>19</sup>/<sub>32</sub>, 15.1mm) CD Exposure 1 Plywood subfloor panels, (Exposure 1), 4'x8' sheets.
  2. Installation method:
    - a. Cut the plywood panels to 2'X8' or 4'X4' sections.
    - b. Score the back of the panels 1/2 the thickness on a 12"x12" grid.
    - c. Apply an adhesive approved for the installation of plywood, per the plywood manufacturer's recommendations.
    - d. Lay sections in a staggered joint pattern in the adhesive, with 1/8" spacing between sheets, and 3/4" minimum expansion space at walls and all vertical obstructions.

### **Part IV - Nail-Down Subfloor**

- A. Always follow the manufacturer's recommendation for proper subfloor.
- B. In on-grade and below-grade applications, always add vapor retarder before applying underlayment. In above-grade applications, follow the flooring manufacturer's recommendations.
- C. A vapor retarder is recommended anytime solid 3/4" wood flooring is installed over concrete.
- D. Nail-Down Subfloor System Over Concrete
  1. Materials
    - a. Minimum: use nominal 5/8" (<sup>19</sup>/<sub>32</sub>, 15.1mm) CD Exposure 1 Plywood subfloor panels (CDX), 4'x8' sheets
  2. Installation method

**NOTE: Fasteners may be powder-driven pins, pneumatic driven nails, screws, deformed pins, or other fasteners suitable for concrete application. Check with fastener manufacturer for specification such as length, drill size, and/or shot load where applicable.**

- a. Stagger panel joints allowing approximately  $\frac{1}{8}$ " expansion space around all panels to prevent edge peaking due to compression caused by panel swell.
- b. Allow  $\frac{3}{4}$ " minimum expansion space at all vertical obstructions.
- c. Panels should be mechanically fastened. For powder load or pneumatic pressure information, contact your local supplier.
- d. Fasten 2" from the edge every 6-8" along the perimeter of the sheet and one fastener or more spaced every 12" in the interior of the panel. Fasten the center first to prevent the subfloor from bowing. (See diagram at right.)

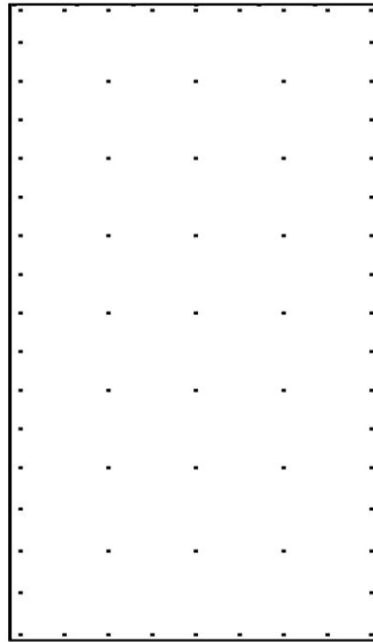

- e. Areas with higher humidity may require additional fasteners.

## **Part V - Screed System**

- A. Solid  $\frac{3}{4}$ ", 25/32" and 33/32" tongue-and-groove strip flooring may be installed directly to screeds.
- B. Engineered wood flooring less than  $\frac{3}{4}$ " (23/32") thick, thin-classification strip flooring (including  $\frac{1}{2}$ ") and solid plank flooring (4" or wider) cannot be installed directly to screeds.
- C. For engineered flooring less than  $\frac{3}{4}$ " thick, thin-classification strip, and for solid plank (4" and wider), the screed system must be overlaid with proper subflooring. The screed system must be overlaid with nominal  $\frac{3}{4}$ " (23/32" 18.3mm) Exposure 1, or nominal 5/8" (19/32" 15.1mm), Exposure 1, CDX plywood subfloor panels or nominal  $\frac{3}{4}$ " (23/32", 18.3mm) OSB underlayment properly spaced and oriented perpendicular to screed direction. All joints must be staggered.
- D. Installation method. See Appendix I, Installation Over Screeds.



# SECTION III

## INSTALLATION GUIDELINES & METHODS

CHAPTER 7	PARQUET INSTALLATION .....	Page 1
CHAPTER 8	ENGINEERED FLOORING INSTALLATION .....	Page 7
CHAPTER 9	SOLID STRIP & PLANK INSTALLATION .....	Page 11
CHAPTER 10	INSTALLATION OVER EXISTING FLOORS .....	Page 15

# CHAPTER 7

## PARQUET INSTALLATION

### Part I - Acceptable Jobsite Conditions and Jobsite Checklist

- A. Refer to Chapter 1

### Part II - Acclimation Guidelines

- A. See Chapter 2 and Appendix B.

### Part III – Appropriate Grade Levels

- A. Solid parquet wood floors can be installed successfully above grade level or on grade, but are not recommended for installation below grade.
- B. The entire flooring level is considered to be BELOW GRADE where soil is present along any perimeter wall and is more than 3” above the installed wood flooring level. Ground should be sloped away from the house for proper drainage. (Follow local building codes.)

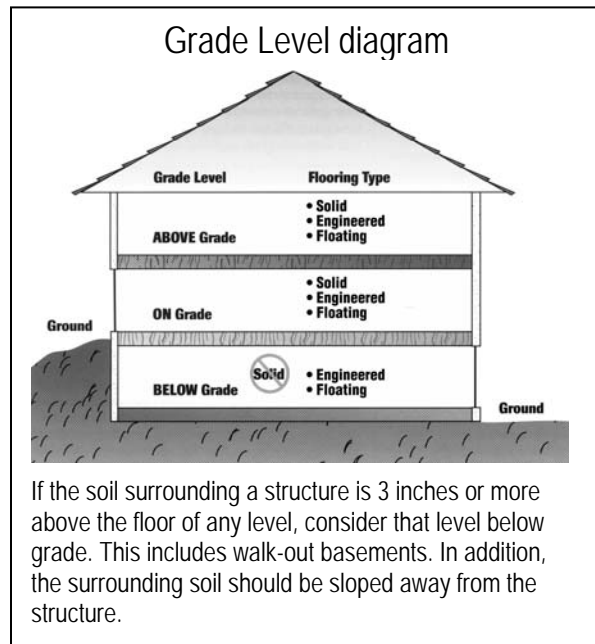

### Part IV - Subfloors – Wood Joist Systems

- A. See Chapter 4.
- B. Parquet cannot be installed directly to solid board subfloors. For parquet installations, board subfloors must have additional underlayment.

### Part V - Subfloors – Concrete Slab

- A. See Chapters 5-6.



## Part VI – Parquet Installation Methods

- A. Follow manufacturer's recommendations.
  1. The styles and types of block and parquet flooring, as well as the recommended procedures for application, vary somewhat among manufacturers. Detailed installation instructions are usually provided with the flooring or are available from the manufacturer or distributor.
- B. Test wood subflooring for moisture according to moisture testing procedures. (See Chapter 3.)
- C. Test concrete for moisture according to moisture testing procedures in Chapter 3. Moisture indicators should be within the adhesive and flooring manufacturers' specifications.
- D. A minimum expansion space of  $\frac{1}{2}$ " must be left around the perimeter and all vertical obstructions.
- E. Some  $\frac{3}{4}$ " parquet is appropriate for nail-down installation, as long as the pattern continues to have an exposed side tongue in which to nail.
- F. Lay blocks and/or individual pieces of parquet in adhesive.
- G. Use the wood manufacturer's approved adhesive. Follow the spread rate, trowel size and installation procedure as recommended by the adhesive manufacturer.

## Part VII – Parquet Layouts

- A. Square Layout from the Center of the Room (See Figure 7-1)

**NOTE: For instructions on using the trammel point method to square a room and find the center point, see Appendix G, Trammel Point Method.**

1. Start by snapping a chalk line through the center of the room (line Y). The next line (X) must be exactly 90 degrees to line Y to form a perfect square corner. To ensure this angle, do the following:
2. From the center point (A) of line Y, measure 4 feet along line Y and mark that point (B).
3. From the same center point, measure 3 feet in the general direction of where line X will be and scribe an arc.
4. Return to the original 4-foot mark on line Y and measure 5 feet, scribing an arc that crosses (point C) the 3-foot arc you made in the previous step.
5. Verify all measurements before proceeding.
6. If correct, snap a chalk line through the conjunction of the two arcs at point C and the center point of line Y. This will be line X, at an exact 90-degree angle to line Y.

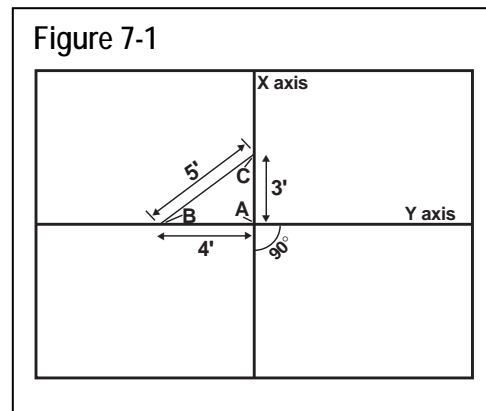

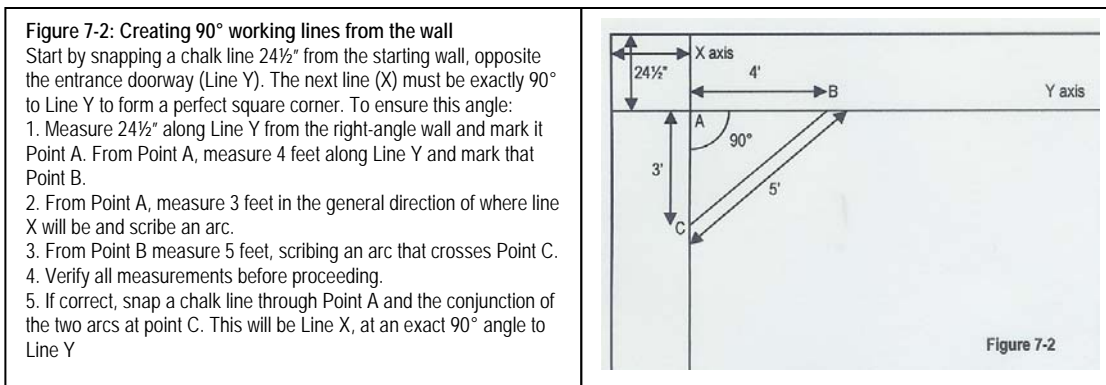

**B. Square Layout from the Wall (See Figure 7-2)**

Square edge block or basket weave parquet can be laid wall to wall without centering the tiles on the room. The results will not be balanced but the tiles have no edge treatment to delineate the difference in tile sizes when unbalanced. More intricate patterns generally require the flooring to be centered.

**1. Wall Line Layout**

- a. If the room dimensions allow, in at least two places from the corner, measure out and establish a chalk line parallel to and 24½" (62cm) away from the starting wall opposite the entrance doorway. The ½" (12.7 mm) is for expansion space.
- b. Snap a second chalk line 90 degrees to the first chalk line using the method shown in Figure 7-2, 24½" (62cm) away from the right angle wall. The ½" is for expansion space.
- c. Make any necessary adjustments to allow for walls out of square before proceeding.

**C. Installation Using Wall Layout (See Figure 7-3)**

**1. Spread the Adhesive**

- a. After both chalk lines (at 90 degrees to each other and 24½" (62cm) from the wall) have been snapped, start spreading the adhesive in the 24½" (62cm) wide area next to the starting wall.
- b. Continue spreading the adhesive along the entire length of the starting wall. Be careful not to spread adhesive beyond the 24½" (62cm) chalk line.

**2. Immediately lay the floor tiles on the newly spread adhesive**

**3. DO NOT** lay the floor tiles on dry adhesive. If the adhesive becomes too dry, scrape up the old adhesive and spread more.

**4. IMPORTANT:** Stand or kneel on the subfloor during the installation to avoid shifting the tiles.

**5. PROPER PLACEMENT OF THE FIRST FLOOR TILE IS THE KEY TO THE ENTIRE INSTALLATION.** Carefully place a 12" x 12" (30 x 30 cm) parquet tile at the intersection of the two chalk lines. (See Figure 7-3.) Do not use the edge of the tongue for aligning the tile on the chalk lines.

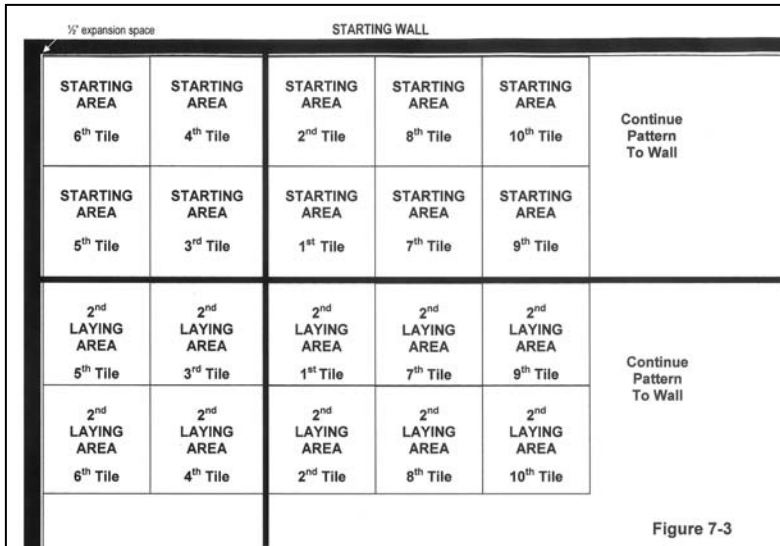
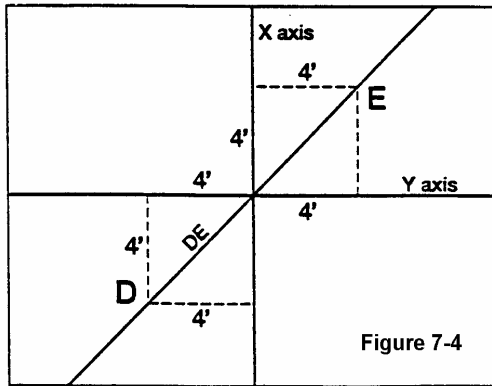

Figure 7-3

When the starting area has been completed, including cutting to the wall, proceed to the second laying area, then to laying areas 3, 4, 5, etc., repeating the installation procedure of the starting area.

6. Lay the second floor tile ahead of the first tile to fit  $\frac{1}{2}$ " (12.7 mm) from the starting wall. Gently lock in the tongue and groove between the first and second floor tiles.
7. Re-check to be sure both floor tiles are properly lined up with the chalk line. This is to assure a square starting area.
8. Continue laying the balance of the 12" x 12" (30.48 cm) floor tiles along the starting wall area. Put each floor tile in place and gently push the floor tiles together to interlock the tongue and groove. Align each floor tile squarely.
9. Do not push the floor tiles too strenuously as this could cause the first and second floor tiles to move. Simply realign them and proceed with the installation. Avoid hammering or forcing the floor tiles together as this may destroy the squareness of the floor tile.
10. After laying the floor tiles across the first 24 $\frac{1}{2}$ " (30.48 cm) starting area, trim the last floor tiles as needed to obtain the proper  $\frac{1}{2}$ " (12.7 mm) expansion space next to the walls. Use a small band or saber saw for final trimming. Firmly secure each floor tile when cutting with a saber saw..
11. Complete the installation
  - a. When the starting area has been completed, including cutting to the wall, proceed to the second laying area. (See Figures 7-3.)
  - b. Cut the last floor tiles to allow a  $\frac{1}{2}$ " (12.7 mm) expansion space from the end wall.
  - c. Proceed by laying areas 3, 4, 5, etc., repeating the installation procedure of the starting area. Trim out each laying area before proceeding to the next area.
  - d. Maintain the  $\frac{1}{2}$ " (12.7 mm) expansion space around the perimeter of the room and around all fixed objects.
  - e. Allow a minimum of 24 hours drying time before moving furniture or walking on the newly laid parquet floor.

D. Diagonal Layout (See Figure 7-4)



1. Establish a 45-degree working line:
2. From the center point, measure 4 feet down in each direction on lines X and Y, which you have already determined by the method described above.
3. From each of these points, measure 4 feet and scribe an arc. The conjunction of these arcs creates points D and E.
4. Snap a chalk line between points D and E, and the center point. This line represents a 45-degree angle.

D. Herringbone Layout

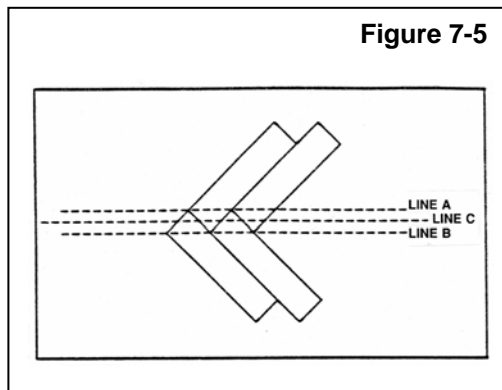

1. Use reference lines throughout the area that is being installed.
2. The multiple of the width should equal the exact length of the piece. If the width of the product varies, this will cause separations at the end of the herringbone pieces.
3. Herringbone parquet can be laid out parallel or at a 45-degree angle to the room. Regardless of direction, Herringbone parquet will require a centerline and two working lines (See Figure 7-5).
4. Begin by laying out a few alternating slats.

5. Snap lines A & B through the corners of the alternating slats (See Figure 7-5)
6. Measure the distance from Line A to Line B. Line C should be  $\frac{1}{2}$  that distance and run parallel to Lines A & B. The centerline of the room and the center of the pattern is represented by Line C.

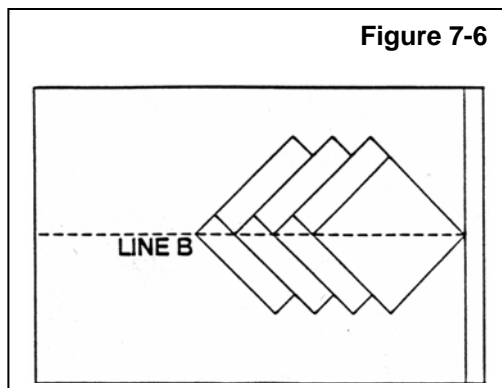

E. Herringbone Installation

1. To begin installation on working Line B (See Figure 7-6), cut a square piece of plywood the size of the herringbone pattern. For example, if the herringbone pattern is 3 inches by 12 inches, cut a 12" x 12" square of plywood.
2. Fasten the piece of plywood at your starting point on Line B, with one corner of the square pointing in the direction of the pattern.

# CHAPTER 8

## ENGINEERED WOOD FLOORING INSTALLATION

### Part I - Acceptable Jobsite Conditions and Jobsite Checklist

A. Refer to Chapter 1

### Part II - Acclimation Guidelines

A. See Chapter 2 and Appendix B.

### Part III – Appropriate Grade Levels

- A. Engineered wood floors can be installed successfully on, above or below grade level. Engineered wood floors can be installed directly to concrete or wood subfloor.
- B. The entire flooring level is considered to be BELOW grade where soil is present along any perimeter wall and is more than 3” above the installed wood flooring level. Ground should be sloped away from the house for proper drainage. (Check local building codes. Local building codes prevail. Follow local building codes.)

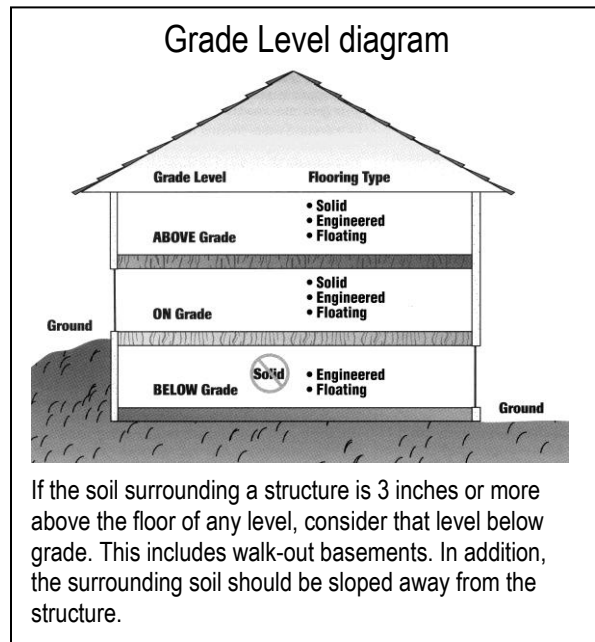

### Part IV - Subfloors – Wood Joist Systems

A. See Chapter 4.

### Part V - Subfloors – Concrete Slab

A. See Chapters 5-6.

### Part VI – Engineered Flooring Installation Methods

- A. Engineered wood flooring can be installed directly to screeds, provided the engineered flooring is a minimum of 3/4” thick. For engineered flooring less than 3/4” thick, the screed system must be overlaid with proper subflooring. See Appendix I, Installation Over Screeds.
- B. Note on random-width plank
1. Random-width plank is laid out with alternating courses varying by widths. Start with the widest board, then the next width, etc., and repeat the pattern.

### C. Choose a Starting Wall

1. Choose a starting wall according to the most aesthetically or architecturally important elements in the room, taking into consideration fireplaces, doors, cabinets and transitions, as well as the squareness of the room. The starting wall will often be the longest unbroken wall in the room.

### D. Glue-Down Engineered Strip and Plank

1. There are several different ways to start the installation of glue-down engineered wood flooring. The following has proven successful. However, where instructions differ from manufacturer recommendations, manufacturer recommendations prevail.
2. Test the substrate for moisture according to appropriate moisture testing procedures in Chapter 3. Excessive/elevated moisture should not be present. The subfloor should be within acceptable moisture content as per adhesive and wood manufacturer's recommendation before installing.
3. Expansion space should be left around the perimeter in accordance with the manufacturer's recommendation.
4. Snap a working line parallel to the starting wall, the width of the board, plus the tongue and recommended expansion space.
5. Install a starter board along the edge of the working line and begin installation. Alternatively, lay one row of plank in the adhesive along the length of the working line.
6. Follow manufacturer instruction for tongue and groove direction and placement.
7. Use an adhesive approved by the flooring manufacturer. Follow the installation procedure recommended by the adhesive manufacturer, which includes subfloor moisture content, spread rate, trowel size, open time, working time and flash time as necessary. Spread the adhesive as instructed up to and along the working line.
8. Distribute lengths, avoiding "H" patterns and other discernible patterns in adjacent runs. Stagger end joints of boards row to row a minimum of 6" for strip flooring, 8-10" for 3" to 5" plank, and 10" for plank wider than 5". (See Figures 8-1 and 8-2.)
9. If recommended by the manufacturer, use tape or tensioners to maintain a tight floor.
10. If recommended by the adhesive manufacturer, roll the floor with the proper roller.

### E. Mechanically Fastened Strip and Plank

1. If necessary, add a vapor retarder.
2. Snap a working line parallel to the starting wall, allowing expansion space as specified by the manufacturer.
3. Lay one row of plank along the entire length of the working line.

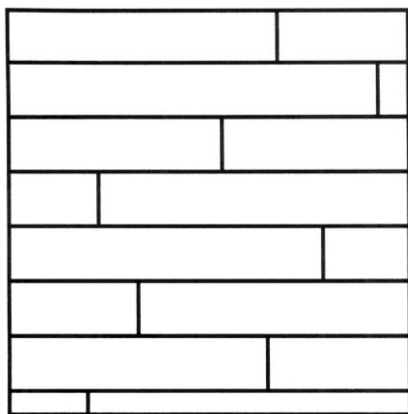
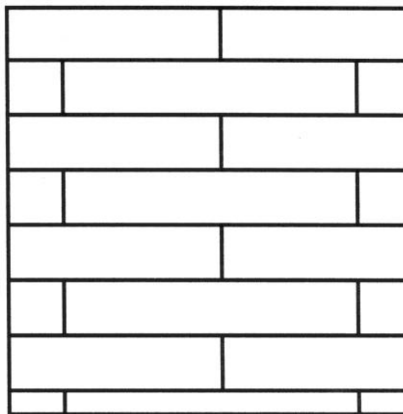
**Figure 8-1 Stagger End Joints**

**Figure 8-2 Avoid “H” Joints**

4. Top-nail and blind-nail the first row (hand-nail if necessary), using appropriate fasteners. Denser species may require pre-drilling. Each succeeding row should be blind-nailed wherever possible.
    - a. Typical: narrow crowned (under 3/8”) 1”-1½” staples or 1”-1¼” hardwood flooring cleats designed for engineered flooring, spaced as recommended by the manufacturer.
    - b. Typical: every 3-4” with staples, every 4-6” with cleats, and within 1-2” of end joints. Use appropriate size fastener for top nailing first row, last row and any area where blind nailer will not fit.
  5. Add each additional row of flooring. Distribute lengths, avoiding “H” patterns and other discernible patterns in adjacent runs. Stagger end joints of boards row to row a minimum of 6” for strip flooring, 8-10” for 3” to 5” plank, and 10” for plank wider than 5”.
  6. During installation of flooring pieces, push or gently tap boards flush to the previous row. Tap against the tongue; tapping the groove may damage the edge. To prevent damage to the finish, avoid tapping the face of the board with a rubber mallet.
- F. Floating Engineered Flooring
1. Subfloor flatness is critical to the success of a floating floor installation. (See Chapter 4, Wood Subfloor Guidelines, and Chapter 5, Concrete Subfloor Guidelines.)
  2. Test the substrate for moisture according to appropriate moisture testing procedures in Chapter 3. Excessive/elevated moisture should not be present. The subfloor should be within acceptable moisture content as per manufacturer recommendation before installing.
  4. If necessary, add vapor retarder. (See Acceptable Vapor Retarders in Chapter 3, Moisture Requirements and Moisture Testing.)
  5. Expansion space should be left around the perimeter or in accordance with manufacturer’s recommendation.

6. Typical: Subfloors are covered with a resilient material, foam underlayment or cork. Follow manufacturer's instructions for correct materials and thickness.
7. Typical: floating engineered flooring is edge-glued or edge-attached with a self-locking mechanism.
  - a. For edge-glued products, use an adhesive approved by the manufacturer.
  - b. Apply adhesive at the spread rate to the side grooves and/or ends as recommended by the manufacturer.
8. Starter boards should be aligned with the groove side and end against the starting wall. Tapping block should be used against tongue only.
9. Stagger end joints per manufacturer's recommendation. Typical: 18"-20".



# CHAPTER 9

## SOLID STRIP AND PLANK FLOORING INSTALLATION

### Part I - Acceptable Jobsite Conditions and Jobsite Checklist

A. Refer to Chapter 1

### Part II - Acclimation Guidelines

A. See Chapter 2 and Appendix B.

### Part III – Appropriate Grade Levels

- A. Solid strip and plank wood floors can be installed successfully above grade level or on grade, but are not recommended for installation below grade.
- B. The entire flooring level is considered to be BELOW GRADE where soil is present along any perimeter wall and is more than 3” above the installed wood flooring level. Ground should be sloped away from the house for proper drainage. (Follow local building codes.)

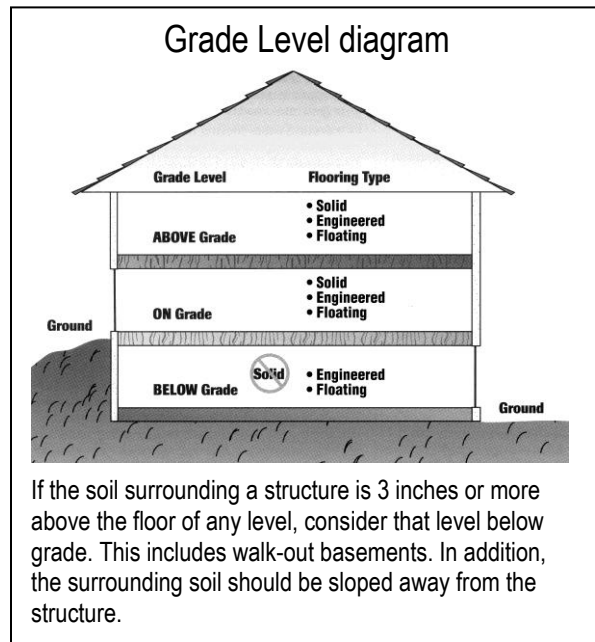

### Part IV - Subfloors – Wood Joist Systems

A. See Chapter 4.

### Part V - Subfloors – Concrete Slab

- A. See Chapter 5.
- B. When installing solid strip and solid plank flooring over concrete, a vapor retarder is always required over the concrete slab and below the subflooring material. A minimum 6 mil construction grade polyethylene film, with perm of .13, or other impermeable material with a perm of .15 or less is recommended.
- C. Some manufacturers allow direct glue installation of ¾” solid strip and solid plank flooring. In such cases, follow manufacturer’s recommendation.

## **Part VI – Solid Strip & Plank Installation Methods**

- A. Always follow the manufacturer's recommended installation procedure.
- B. Unfinished and factory-finished solid strip and solid plank flooring should be installed perpendicular to the joists or on a diagonal for any single layer subfloor. (Exception: Over diagonal, solid subfloor boards, install perpendicular to joists or subfloor direction.)
- C. When  $\frac{3}{4}$ " solid strip and solid plank flooring is laid parallel with the floor joists, follow one of these two steps:
  - 1. Add a layer of minimum nominal  $\frac{1}{2}$ " (15/32") CD Exposure 1 (CDX) plywood underlayment to the existing subfloor (as previously recommended)
  - 2. Or brace between truss/joists in accordance with the truss/joist manufacturer's recommendations and with local building codes. Some truss/joist systems cannot be cross-braced and still maintain stability.
- D. Before installing wood flooring, place an approved vapor retarder. Some examples of acceptable vapor retarders over wood subfloors include:
  - 1. An asphalt laminated paper meeting UU-B-790a, Grade B, Type I, Style 1a.
  - 2. Asphalt-saturated kraft paper or #15 or #30 felt that meets ASTM Standard D-4869 or UU-B-790, Grade D.
- E. Wall Line Layout
  - 1. Choose a starting wall according to the most aesthetically or architecturally important elements in the room, taking into consideration fireplaces, doors, cabinets and transitions, as well as the squareness of the room. The starting wall will often be the longest unbroken wall in the room.
  - 2. Snap a working line parallel to the starting wall, allowing  $\frac{3}{4}$ " expansion space between the starting wall and the edge of the first strip or plank run.
  - 3. As a general rule, a  $\frac{3}{4}$ " expansion space must be left around the perimeter and at all vertical obstructions.
  - 4. Random-width plank is laid out with alternating courses varying by widths. Start with the widest board, then the next width, etc., and repeat the pattern.
  - 5. Lay one row of strip or plank along the entire length of the working line.
  - 6. Top-nail and blind-nail the first row (hand-nail if necessary), using appropriate fasteners. Denser species may require pre-drilling. Each succeeding row should be blind-nailed with the nailing machine wherever possible. At the finishing wall and other obstructions, it may be necessary to blind-nail by hand until top nailing is required.
  - 7. Racking rule of thumb: Avoid "H" patterns. Stagger end joints of boards row to row a minimum of 6" for strip flooring, 8-10" for 3" to 5" plank, and 10" for plank wider than 5". See Figures 9-1 and 9-2.
  - 8. To minimize expansion on floors wider than 20 feet, more or less spacing between rows may be needed, depending on geographical area, interior climate control and time of the year. (Appendix B, Acclimation.)

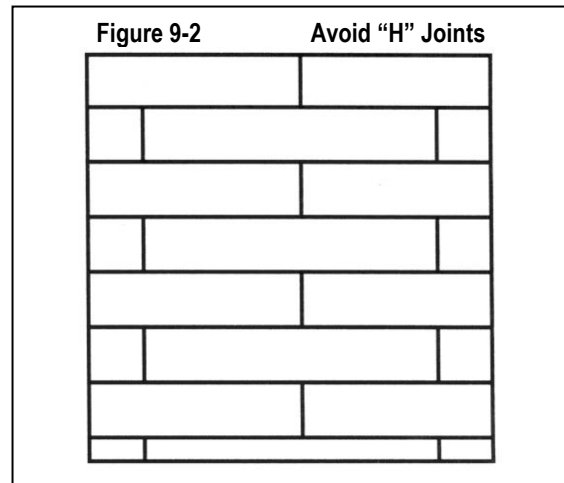
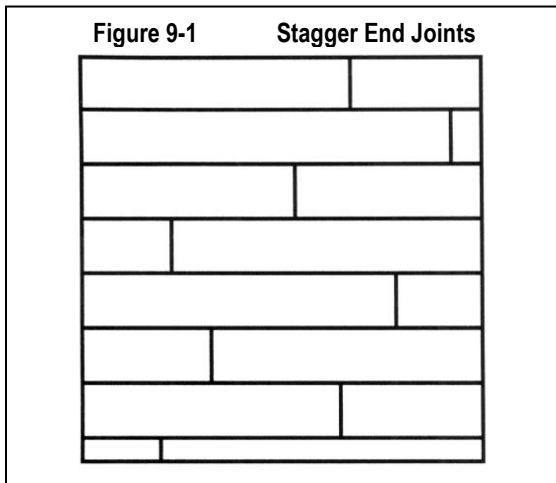

9. Where spacing is required: Use a washer or removable spacer to leave additional space every few rows and/or start in center of room and work out to both sides. Do not use spacers that may cause damage on factory-finished products.
10. Nailing: Blind-nail through the tongue using 1½"-2" fasteners. Use 1½" fasteners with nominal ¾" plywood subfloor direct to concrete slab. Face-nail boards where needed using 6d-8d casing or finish nails. Fasteners should be spaced every 6"-8" on blind-nailing, or every 10"-12" on face-nailing.
11. For additional fastening, any of the following options may be used in addition to the nailing schedule. (See Appendix F, Fastener Schedule.)
12. Follow manufacturer's instructions for installing plank flooring.
13. For wide-width plank flooring (5" or wider), to assist the nailing schedule of 6"-8" and increase holding power, there are three options.
  - a. Screw and plug at end joints, alternating at staggered locations and intervals along each board.
  - b. Apply an approved wood flooring adhesive.
  - c. Use kerfing or relief cuts every 8" to 12" parallel to the grain – using more relief cuts for wider boards. Typically, the relief cut should be 3/8" on a ¾" board.

**NOTE: These options, however, will not necessarily eliminate cupping.**

14. Blind-nail and face-nail, as necessary, to complete the final rows.

#### F. Center Line Layout

**NOTE: For instructions on using the trammel point method to square a room and find the center point, see Appendix G, Trammel Point Method.**

1. Find the center of your room, measuring off the two longest walls, and snap a line down the center of that room.

2. Install a starter board on the line. Fasten the starter board to the floor using wood screws.
3. Nail the first row of wood flooring against the starter board, being careful not to move the starter board when nailing. The groove of the flooring should be against the starter board.
4. Drill and hand-nail the first three rows through the tongue. **DO NOT USE TOP NAILS.**
5. Use a blind nailer to install the remaining rows of wood flooring. Use the nailing practices described earlier in the chapter.
6. After installing in one direction, remove the starter board and start rows going in the opposite direction.
7. Install a spline or a slip tongue in the groove of the board that was against the straight-edge. Put wood flooring adhesive down the entire length of the groove before installing the spline.
8. Install the spline using a blind nailer. To keep the spline in alignment for the next flooring board, use a scrap piece of wood flooring to run along the length of the spline as you nail.
9. Install the remaining rows in the opposite direction. Use the nailing practices described earlier in the chapter.

# CHAPTER 10

## INSTALLATION OVER EXISTING FLOORS

### Part I – Existing Floor Requirements

- A. Always follow the manufacturers recommendations for installation over existing flooring
- B. Glue-down parquet applications that require the use of PVA adhesives are not recommended over existing sheet vinyl or vinyl and cork tile flooring unless an underlayment is put down first. Underlayment should be in accordance with adhesive and/or flooring manufacturer's recommendations.
- C. Particleboard is not generally an acceptable underlayment, because it lacks stability. Some manufacturers approve particleboard as an acceptable underlayment, as they do not warrant against subfloor movement. In such cases, follow manufacturer's recommendation.
- D. Other types of adhesives may require the use of a primer or vinyl blocker when installing over sheet vinyl or vinyl and cork tile flooring. Follow manufacturer's recommendations.
- E. Nail-down applications may be successful over existing sheet vinyl or vinyl tile if fastener penetration is not significantly diminished and the subfloor meets minimum requirements. Fasteners must penetrate a proper subfloor by at least 5/8".
- F. Wood flooring can be installed over existing ceramic tile, terrazzo, or marble with proper underlayment or adhesives only on manufacturer's recommendation.
- G. Installing wood flooring over an existing wood floor.
  - 1. Sand off old finish and high spots on existing wood floor and prep to clean, dry, sound, flat subfloor. Repair, re-nail or replace loose flooring products.
  - 2. Over an existing glue-down floor, glue direct to the existing floor. Or, if the thickness of the floor will allow it, staple to the existing floor. Check with the flooring manufacturer for recommendations.
  - 3. When installing new wood flooring parallel to an existing solid nail-down floor, add a minimum of  $\frac{3}{8}$ " underlayment over the existing floor to increase stability. Check with the flooring manufacturer for recommendations.
  - 4. When installing new wood flooring at a 45- to 90-degree angle to an existing solid nail-down floor, additional underlayment is not required.



# SECTION IV

## APPENDICES

Appendix A	SAFETY GUIDELINES .....	Page 1
Appendix B	ACCLIMATION .....	Page 3
Appendix C	MOISTURE GUIDELINES & MOISTURE TESTING .....	Page 7
Appendix D	MOISTURE BY AREA – US .....	Page 13
Appendix E	MOISTURE BY AREA – CANADA .....	Page 15
Appendix F	FASTENER SCHEDULE .....	Page 17
Appendix G	TRAMMEL POINT METHOD .....	Page 19
Appendix H	RADIANT HEAT INSTALLATIONS .....	Page 21
Appendix I	INSTALLATION OVER SCREEDS .....	Page 27
Appendix J	SOUND CONTROL .....	Page 29
Appendix K	TRIM & THRESHOLDS .....	Page 31
Appendix L	SAMPLE SPECIFICATION .....	Page 33
Appendix M	JOBSITE CHECKLIST .....	Page 37

# APPENDIX A

## SAFETY GUIDELINES

### Safety first

Safety on the job is the foremost concern for contractors, because accidents with power tools can be critical, even disabling or deadly. No amount of experience or expertise exempts you from safety risks inherent in using the tools required to install hardwood floors. The good news is that these risks are easily managed. Start with these general guidelines:

- Never work under the influence of alcohol, drugs or medication
- Work with others nearby, if possible.
- Do not work on a cluttered floor.
- Use proper lighting and ventilation.
- Make sure that the electrical power and wiring at the jobsite is sufficient to operate all machines safely.
- Know your insurance company's policy on coverage related to accidents or jobsite situations.
- Wear proper work clothing and shoes. Do not wear loose clothing that could get caught in a machine.
- Wear NIOSH-approved hearing protection and safety glasses, as well as dust and fume respirators, knee protection and gloves.
- Have an OSHA-approved first-aid kit on the job site.
- Read and fully understand the owner's manuals that are supplied with the equipment.
- Use tools only as intended.
- Use all tool and machine safety guards.
- Turn off and unplug electrical tools and machines when making adjustments and attaching accessories.
- Turn off all sources of ignition when using flammables.
- Use ground fault circuit interrupters (GFCIs) on electric tools to avoid electric shock.
- Carry and read MSDS (Material Safety Data Sheets) for all products.
- Do not exceed manufacturer's recommended working air pressure for pneumatic systems.

# APPENDIX B

# ACCLIMATION

## ALWAYS FOLLOW MANUFACTURERS' RECOMMENDATIONS REGARDING HOW AND WHETHER TO ACCLIMATE WOOD FLOORING.

Wood flooring is a hygroscopic material subject to dimensional change as a result of variations in moisture, temperature and humidity in the surrounding environment. That has led to increasing awareness of the need to properly acclimate wood flooring before installation. Wood flooring simply needs to reach a moisture content level in equilibrium with the surrounding environment in which it will be installed, at or near normal living conditions. Always account for time of year and geographic location.

NOTE: Not properly acclimating wood flooring may cause excessive expansion, shrinkage, dimensional distortion or structural damage

The point of acclimating wood flooring before installation is to allow the moisture content of the wood to adjust to the installation site's "normal living conditions" — that is, the temperature, humidity conditions and moisture content that will typically be experienced once the structure is occupied.

For site-finished wood flooring, after installation and before sanding and finishing, allow the flooring to acclimate to the controlled environment, and to stabilize for a period of time.

**The worst-case scenario is one in which wood flooring is stored at the jobsite in an uncontrolled environment — especially one that is subject to excessive moisture and humidity conditions. It does no good at all — in fact it is likely harmful — to store wood flooring at the jobsite under conditions that don't reflect those normal environmental conditions. Garages, basements and exterior patios, for example, are not acceptable areas to store wood flooring.**

### Wood's Comfort Zone

As a general rule, with geographic exceptions, wood flooring will perform best when the interior environment is controlled to stay within a relative humidity range of 30 to 50 percent and a temperature range of 60° to 80° Fahrenheit. (In some climates, the ideal humidity range might be higher or lower – 25 to 45 percent or 45 to 65 percent, for example.)

The chart on the following page indicates the moisture content wood will likely have at any given combination of temperature and humidity. Note that equilibrium moisture contents in the recommended temperature/humidity range (shaded area) coincide with the 6-to-9 percent range within which most hardwood flooring is manufactured. Although some movement can be expected even between 6 and 9 percent, wood can expand and shrink more dramatically outside that range. When wood is neither gaining nor losing moisture, equilibrium moisture content (EMC) has been reached.



## Equilibrium Moisture Content of North American Wood Species at Various Temperatures and Relative Humidity Readings

**Wood Flooring Has a Comfort Level Too:** Wood flooring will perform best when the interior environment is controlled to stay within a relative humidity range of 30 to 50 percent and a temperature range of 60° to 80° Fahrenheit. Fortunately, that’s about the same comfort range most humans enjoy. The charts below indicate the equilibrium moisture content of North American species of wood under various temperature and humidity conditions. **These values do not necessarily apply to imported species.** The left column indicates temperature in degrees Fahrenheit and Celsius. The bottom row indicates percent relative humidity. The values in the chart indicate the equilibrium moisture content (EMC) for any given combination of temperature and humidity. For example, at 70° Fahrenheit and 40% relative humidity, the equilibrium moisture content is 7.7%. **The shaded area indicates the generally recommended range for wood flooring — 6-9% EMC, which occurs when temperature is 60-80° Fahrenheit or 15-26° Celsius and 30-50% relative humidity.**

° F / C	EMC	EMC	EMC	EMC	EMC	EMC	EMC	EMC	EMC	EMC	EMC	EMC	EMC	EMC	EMC	EMC	EMC	EMC	EMC	EMC
30 / 1	1.4	2.6	3.7	4.6	5.5	6.3	7.1	7.9	8.7	9.5	10.4	11.3	12.4	13.5	14.9	16.5	18.5	21.0	24.3	26.9
40 / 4	1.4	2.6	3.7	4.6	5.5	6.3	7.1	7.9	8.7	9.5	10.4	11.3	12.4	13.5	14.9	16.5	18.5	21.0	24.3	26.9
50 / 10	1.4	2.6	3.7	4.6	5.5	6.3	7.1	7.9	8.7	9.5	10.4	11.3	12.4	13.5	14.9	16.5	18.5	21.0	24.3	26.9
60 / 15	1.3	2.5	3.6	4.6	5.4	6.2	7.0	7.8	8.6	9.4	10.2	11.1	12.1	13.3	14.6	16.2	18.2	20.7	24.1	26.8
70 / 21	1.3	2.5	3.5	4.5	5.4	6.2	6.9	7.7	8.5	9.2	10.1	11.0	12.0	13.1	14.4	16.0	17.9	20.5	23.9	26.6
80 / 26	1.3	2.4	3.5	4.4	5.3	6.1	6.8	7.6	8.3	9.1	9.9	10.8	11.7	12.9	14.2	15.7	17.7	20.2	23.6	26.3
90 / 32	1.2	2.3	3.4	4.3	5.1	5.9	6.7	7.4	8.1	8.9	9.7	10.5	11.5	12.6	13.9	15.4	17.3	19.8	23.3	26.0
100 / 37	1.2	2.3	3.3	4.2	5.0	5.8	6.5	7.2	7.9	8.7	9.5	10.3	11.2	12.3	13.6	15.1	17.0	19.5	22.9	25.6
% RH	5	10	15	20	25	30	35	40	45	50	55	60	65	70	75	80	85	90	95	98

Chart adapted from Wood Handbook: Wood as an Engineering Material (Agriculture Handbook 72) Forest Products Laboratory, U.S. Department of Agriculture

### Coefficients of Change: How Moisture Affects Wood Flooring

At 70° Fahrenheit, a relative humidity of 25 percent gives an EMC of 5 percent, and a relative humidity of 75 percent gives an EMC of 14 percent. A 50 percent variance in relative humidity produces an EMC change of 10 percent. How that affects wood flooring depends on which species is being used. However, let’s say the width variation is just 1/16 inch for a 2¼-inch board. That’s a full inch over 16 boards in a floor. Over the width of a 10-foot wide floor, that amounts to more than three inches of total expansion or contraction. Protective coatings cannot prevent wood from gaining or losing moisture; they merely slow the process. Installers need to take those expected dimensional variations into account when installing the wood flooring.

## Proper Installation By Calculating Coefficients of Change

Proper installation depends not only on the moisture content of the wood and the environmental conditions at the time of installation, but also on expected seasonal changes in temperature and humidity at that location — changes that may cause the wood flooring to gain or lose moisture content over time. Such changes are likely to occur even if the building occupants maintain interior environmental conditions through use of a heating and/or air-conditioning system.

For example, if a wood flooring installation takes place when relative humidity is high, the wood flooring will lose moisture content and therefore shrink during low-humidity seasons. In that case, install the flooring tightly enough to minimize the expected separations that will occur as the boards shrink during dry seasons. Conversely, if an installation takes place when humidity conditions are low, it's likely that the wood flooring will gain moisture and expand during humid seasons. In those cases, incorporate additional expansion space through use of spacers.

How much expansion space to leave will depend on the expected changes in moisture content of the wood flooring, and that will depend on the dimensional change coefficient of the species being installed and the width of the flooring.

**Predicting temperature and humidity changes:** Installers may have a climate history for the areas in which they typically install wood flooring, or climate data is also available from a variety of sources, including the National Weather Service ([www.weather.gov](http://www.weather.gov)) and Weather Underground ([www.wunderground.com](http://www.wunderground.com)).

**Calculating dimensional change:** Different species of wood flooring exhibit different coefficients of change and, therefore, have different rates of dimensional stability. That is, some woods are more prone to expansion and shrinkage than others. The National Wood Flooring Association's *Technical Publication No. A200: Wood Species Used in Wood Flooring* lists dimensional change coefficients for many common wood species used in wood flooring.

To calculate the expected dimensional change in wood flooring, you will need to determine the current moisture content of the wood flooring, using a moisture meter. Then calculate the expected change in moisture content, using the equilibrium moisture content chart above and the climate data for the location in which then flooring is to be installed. Finally, you will need to know the dimensional change coefficient of the species to be installed.

With that information in hand, you will be able to perform a simple calculation that will tell how much the wood flooring is likely to expand or shrink. That calculation multiplies the change in moisture content by the change coefficient, multiplied by the width of the flooring boards.

*Change coefficient x moisture content change x board width = dimensional change*

For example, let's say that climate data for the location indicates that the maximum moisture content for the wood flooring will be 9.1 percent (relative humidity of 50 percent and temperature of 80°). Let's also say that the wood flooring currently has a moisture content reading of 6.1 percent. That means the wood is likely to experience a change in moisture content of 3 percent (9.1% - 6.1%) from dry season to humid season. In the example, let's say that the wood flooring to be installed is 5-inch plank red oak. Red oak has a change coefficient of .00369. We now have the data we need:

Change coefficient = .00369  
Moisture content change = 3%  
Board width = 5 inches

The following calculation would apply:  $.00369 \times 3 \times 5 = .055 \text{ inches}$

In other words, for every 3-percentage-point increase in moisture content, a 5-inch board will expand by more than 1/20<sup>th</sup> of an inch. Over 10 boards, that will equal over ½ inch of expansion — something the installer will need to take into account, although in actual practice the installation and fastening process will tend to restrain board movement somewhat.

## **The Process of Acclimation**

If the manufacturer recommends that the wood flooring be acclimated before installation, proceed as follows:

- First, ensure that the building is enclosed.
- Second, ensure that the building is maintained at normal living conditions for temperature and humidity. It does no good to acclimate flooring to interior conditions that are too moist or too dry, or in any way significantly outside the range of conditions likely to be found in the building after the flooring is installed. In fact, it is counterproductive.
- Where building codes allow, permanent heating and/or air-conditioning systems should be operating at least five days preceding installation to promote proper acclimation. Where building codes do not allow for operation of the permanent system, acclimation of the flooring must be completed with the temperature and humidity maintained at or near normal living conditions, which generally fall between 60° to 80° Fahrenheit and at the average yearly relative humidity for the area.
- If it is not possible for the permanent heating and/or air-conditioning system to be operating before, during and after installation, a temporary heating and dehumidification system using electric heating units, dehumidifiers and industrial fans can enable the installation to proceed until the permanent heating and/or air-conditioning system is operating.
- Upon delivery, check wood flooring moisture content with a moisture meter to establish a baseline for required acclimation. Acclimate to manufacturer's recommendations or as necessary according to geographical location. **See Appendix D, Moisture by Area – U.S., and Appendix E, Moisture by Area – Canada.**
- Acclimation can be facilitated by breaking the floor units into small lots and/or opening the packaging. A common practice is to stack the flooring, with ¾-inch to 1-inch sticks between each layer of flooring to allow air circulation on all sides of all boards.

**Note: Some manufacturers do not require acclimation for certain products prior to installation.**

- For solid strip flooring (less than 3 inches wide), when an industry-approved vapor retarder with a proper perm rating is installed between the flooring and the subfloor, there should be no more than 4 percent moisture content difference between properly acclimated wood flooring and subflooring materials. For wide-width (3" or wider) solid flooring, there should be a moisture content difference of no more than 2 percent between properly acclimated wood flooring and subflooring materials. For wide-width flooring, many industry professionals also suggest using an adhesive as an assist to mechanical fastening. However, the adhesive may not provide sufficient moisture protection to substitute for an industry-approved vapor retarder. Also, when an adhesive is applied over a vapor retarder, care should be taken to ensure that the adhesive and vapor retarder are compatible with one another. In most cases, adhesives are not compatible with asphaltic or paper-type vapor retarders.

# APPENDIX C

## MOISTURE GUIDELINES & MOISTURE TESTING

Determining moisture content is an essential part of quality control within the flooring installation process. Flooring installers must know the moisture content of the wood flooring, as well as the subfloor.

**The most accurate measurement for moisture content in wood is the oven-bake-out method. However, it is not widely used because the cost and difficulty of performing the test on-site is not practical.**

### Moisture Testing for Wood Flooring and Wood Subfloors

Hand-held electrical tools, called moisture meters, should be part of the toolbox of every flooring contractor, for measuring moisture in subfloors and floors.

Moisture meters have many purposes. They can determine if floor boards are dry enough for an installation to proceed. They can check subfloors and concrete for high moisture levels; they can decide when a second coat of finish can be applied; they can assess water damage.

**There are two main types of meters for testing wood – probe and pinless.**

- The probe type, measures electrical resistance across opposed sets of pins, which are pushed into the wood. All probes should be inserted parallel with the grain.

One advantage of probe-type meters is that those with insulated pins can measure moisture content at varying depths – you can tell whether the moisture content near the bottom of a board is higher than near the top, for example.

- The pinless, dielectric types employ signal penetration up to 1 inch or more for both hardwood and softwood. The meter can be moved across the surface to identify pockets of moisture. It is relatively unaffected by temperature. Rough surfaces have very little effect on the reading. Measurements can also be taken through coating, varnish or paint without damage to the surface. Because pinless moisture meters often measure deeper than the ¾" depth of the wood flooring, the moisture readings from the meter may include moisture in the wood subfloor, as well as in the wood flooring. Follow the meter manufacturer's recommendations to get an accurate reading from the wood floor. One effective testing method is to remove a sample board and get a reading with air space beneath it.

It is important that the meter you choose offers the following:

- A wide moisture content range from at least 6 percent to 30 percent.
- The necessary adjustment tables or conversion chart for various species.

Test for moisture at several locations in the room — a minimum of 20 per 1,000 square feet — and average the results. Pay special attention to exterior and plumbing walls. In most regions, a "dry" subfloor that is ready to work on has a moisture content of 12 percent or less. If you record excessively high readings, do not proceed with installation until the origin of the moisture is identified and moisture problems are remedied.

## **Moisture Testing For Concrete Slabs:**

**Note: Before moisture testing begins, the concrete slab must be a MINIMUM of 30 days old.**

Moisture meters for concrete can be probe-type or pinless. Some meters designed to provide qualitative results – that is, the readings they provide can indicate potential moisture problems, but will not provide a definitive reading. In that case, quantitative testing is required.

The two qualitative moisture meters work on the principles of electrical impedance or electrical resistance. These testing methods are not recognized by any standard and should not be used for the purpose of accepting or rejecting a floor. These electronic tests are useful survey tools to broadly evaluate the relative moisture conditions of a slab and to select locations for quantitative moisture tests. If the moisture meters indicate the presence of excessive moisture, as per wood flooring or meter manufacturer's recommendations, further testing is required using relative-humidity testing (ASTM F-2170), calcium chloride testing (ASTM F-1869) or calcium carbide (CM) testing. (See below.)

Another qualitative test is the phenolphthalein test, which requires one test per 200 square feet of surface area, with a minimum of two tests per jobsite. Chip a small section of concrete off the floor and apply 3 percent phenolphthalein in alcohol solution (available at most druggists) in the area. A red color indicates that moisture is present. Always chip the concrete as this protects against the possibility that a concrete sealer was applied. If the phenolphthalein test indicates the presence of excessive moisture, further testing is required using relative-humidity testing (ASTM F-2170), calcium chloride testing (ASTM F-1869) or calcium carbide (CM) testing. (See below.)

## **Quantitative Moisture Tests on Concrete**

### **Relative Humidity Testing - ASTM F-2170**

Select test locations to provide information about moisture distribution across the entire concrete floor slab. For slabs on grade and below grade, include a test location within three feet of each exterior wall.

Perform three tests for the first 1,000 sq ft and one test for every additional 1,000 sq ft thereafter.

At least 48 hours before test is placed, concrete floor slabs should be at the same temperature and humidity that is expected during service conditions.

Use a rotary hammer-drill to drill holes in the concrete slab; 40% depth of slab is required for the holes when concrete is drying from one side and 20% when drying from both sides. **Follow manufacturer's instructions provided with test kits.**

Allow 72 hours to achieve moisture equilibrium within the hole before making relative humidity measurements.

ASTM F-710 provides installation guidelines for acceptance of hardwood flooring using relative-humidity testing. Typical limits for wood and wood-based products are 75% relative humidity. When getting readings over 75%, you must use a proper vapor retarder, based on the flooring manufacturer's recommendations, or wait for further concrete curing.

### **Calcium Chloride Test - ASTM F-1869**

Select test locations to provide information about moisture distribution across the entire concrete floor slab.

Perform three tests per 1,000 square feet of surface area. Add one additional test for each 1000 square feet thereafter.

At least 48 hours before test is placed, concrete floor slabs should be at the same temperature and humidity expected during service conditions

The actual test area shall be clean and free of all foreign substances. Use approved OSHA work practices for removal of all existing flooring materials and debris.

Blast or grind a minimum area of 20 inches by 20 inches and let stand for a minimum period of 24 hours prior to setting test.

Follow manufacturer's instructions for properly placing tests onto concrete.

Tests are to be covered and left in place for 60 to 72 hours. Follow manufacturer's instructions for labeling and recording time and date of test.

Send the test to a certified laboratory for results and documentation, or perform the measurements as per ASTM F-1869.

Always following the flooring manufacturer's guidelines and specifications to determine when the concrete slab is ready for installation.

ASTM F-710 provides installation guidelines for acceptance of hardwood flooring using calcium-chloride testing. Typical limits for direct glue-down wood flooring is 3lbs/1000sf/24hr. When getting readings over 3 lbs and up to 7 lbs, you must use a vapor retarder. A reading over 7 lbs may not be acceptable for wood flooring installation. Follow the wood flooring manufacturer's recommendations. In the case of a glue-down installation, the adhesive manufacturer may also have recommendations.

NOTE: For information on the tests listed above, contact your distributor or call NWFA at 800-422-4556 U.S. or 800-848-8824 Canada for the source nearest you.

### **Calcium Carbide (CM) Test - ASTM (modified) D-4944-04, MilSpec CRD-C154-77**

The calcium carbide test, also known as the CM test or calcium carbide bomb, is more widely used in Europe than in the United States. It is a gas-pressure test in which moisture in the concrete reacts with calcium carbide crystals to create acetylene gas, and the gas pressure produced is measured to provide a moisture content reading, expressed as a percentage of moisture. Follow the directions provided by the test-kit manufacturer. A reading of over 2.5% requires use of a vapor retarder. A reading over 4% may not be acceptable for wood flooring installation. Follow the wood flooring manufacturer's recommendations. In the case of a glue-down installation, the adhesive manufacturer may also have recommendations.

The testing method generally requires the collection of specific weighed quantities of concrete from the floor by chipping or drilling. A specific quantity of carbide is added, as well as two or more steel balls and the chamber is sealed. The materials are rolled or shaken to mix and to allow the steel balls to pulverize the test materials. Carbide reacts with moisture in the test materials creating acetylene gas that is measured on an attached pressure gauge.

## **Acceptable Vapor Retarders Over Wood Subfloors**

ALWAYS FOLLOW LOCAL CODES AND MANUFACTURERS INSTRUCTIONS FOR ACCEPTABLE VAPOR RETARDERS.

An acceptable vapor retarder is a vapor resistant material, membrane or covering with a vapor permeance (perm rating) of greater than or equal to .7 and less than or equal to 50 when tested in accordance with ASTM E-96 Method A. Installation of a vapor retarder reduces the potential for moisture or vapor related problems, but does not guarantee elimination of moisture or vapor related problems. Install a vapor retarder over wood panel or board sub-floors prior to installing nail down solid strip or plank flooring. Over-lap seams a minimum of 4 inches or more as required by manufacturer or specifier and local building codes.

**Some examples of acceptable vapor retarders over wood subfloors include:**

1. An asphalt laminated paper meeting UU-B-790a, Grade B, Type I, Style 1a.
2. Asphalt-saturated kraft paper or #15 or #30 felt that meets ASTM Standard D-4869 or UU-B-790, Grade D.

### **NOTE:**

1. A vapor retarder has some extra benefits in that it eliminates wood-on-wood contact, wood boards slide more easily when positioned, minimizes the impact of seasonal humidity change and may reduce dust and noise levels.
2. However, by today's standards, asphalt saturated kraft or felt paper may not be an effective vapor retarder in all applications. The 2006 International Residential Code requires a vapor retarder on the warm-in-winter side of exterior floors (a floor over a vented crawl space, for example), with a vapor permeance of 1 perm or less in Zones 5 and higher.
3. Over a wood subfloor, do not use an impermeable vapor retarder material with a perm rating of .7 or less, such as 6 mil polyethylene film or other polymer materials, as it may trap moisture on or in the wood subfloor.
4. Do not use common red rosin or building paper which is not asphalt saturated. They are not vapor retarders as their perm rating is far greater than 50.

## **Acceptable Vapor Retarders Over Concrete**

- A. ALWAYS FOLLOW LOCAL CODES AND MANUFACTURERS INSTRUCTIONS FOR ACCEPTABLE VAPOR RETARDERS.
- B. Test concrete for moisture. For concrete slabs with a calcium chloride reading of greater than 3 lbs, a relative humidity reading of greater than 75%, or a calcium carbide (CM) rating of greater than 2.5%, install an impermeable vapor retarder with a perm rating of less than .15 perm. Adding a vapor retarder is not required on installations over slabs with a calcium chloride reading of 3 lbs or less, a humidity reading of 75% or less, or a calcium carbide (CM) rating of 2.5% or less. However, in on-grade and below grade applications, adding a vapor retarder is always recommended.
- C. The 2006 International Residential Code defines a vapor retarder as a vapor-resistant material, membrane or covering such as foil, plastic sheeting or other material

recommended by the manufacturer having a permeance rating of 1 perm or less, when tested in accordance with ASTM E-96 Method A.

- D. The NWFA recommends an "impermeable" vapor retarder with a perm rating of less than or equal to .15, thereby limiting the passage of moisture to near zero.
- E. Some acceptable vapor retarders over concrete include:
1. A minimum 6 mil construction grade polyethylene film, with perm of .13, or other impermeable material with a perm of .15 or less is recommended. A premium polymer material meeting ASTM D-1745 for concrete with higher tensile, tear and puncture resistance is highly desirable.
  2. Double felt: Two layers of #15 asphalt saturated felt paper that meets ASTM Standard D-4869, with the first layer adhered to the slab in a skim coat of appropriate adhesive, and a second layer adhered to the first layer with appropriate adhesive.
  3. A chemical retarder or urethane membrane, as recommended by the adhesive or wood flooring manufacturer. These are usually in the form of a liquid-applied or trowel-applied membrane dispensed from a bucket following manufacturer recommendations.



# APPENDIX D

## MOISTURE CONTENT BY AREA – U.S.

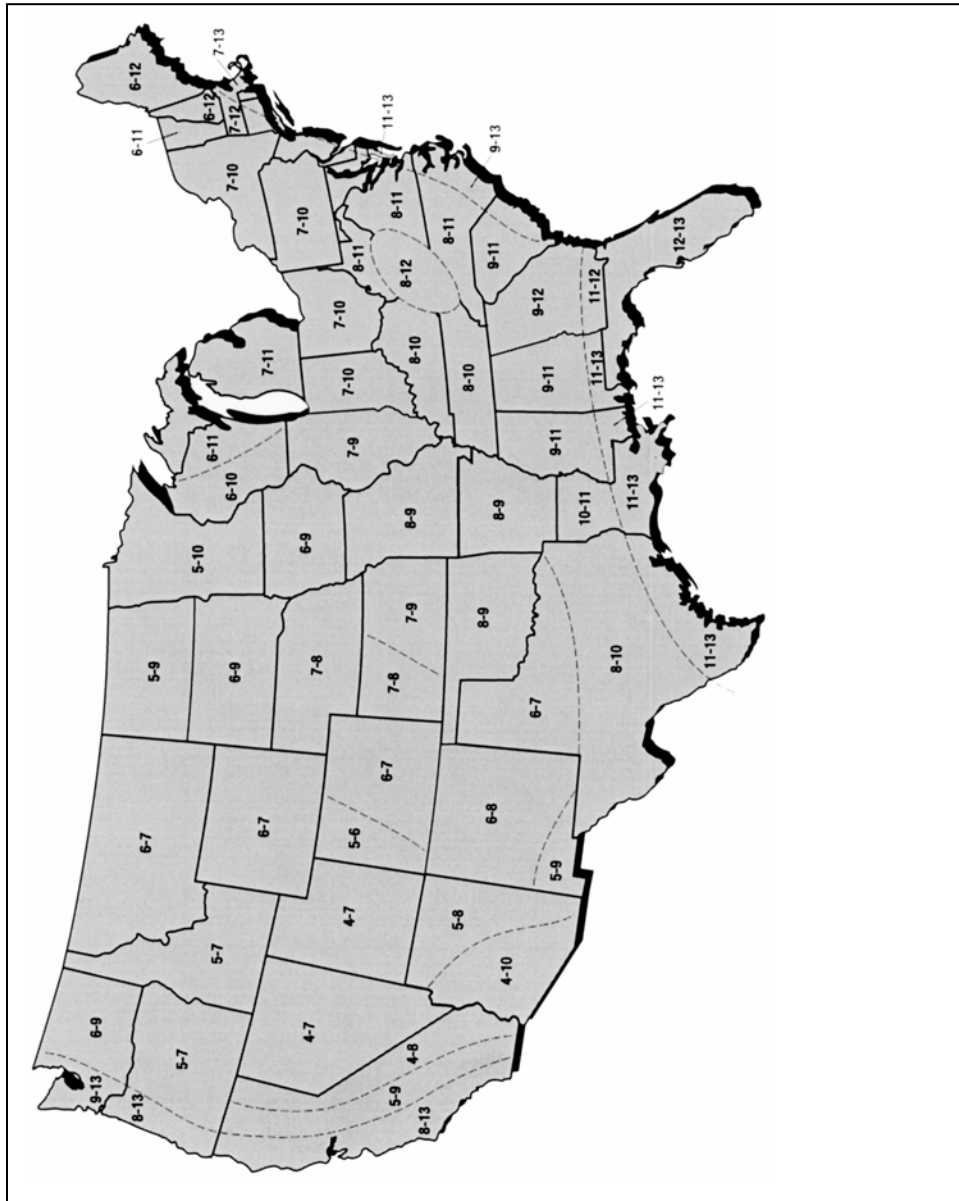

**NOTE:** Relative humidity in the building should be maintained at between 30-50 percent year-round.  
A consistent interior climate environment is the key to optimum wood flooring performance.

# APPENDIX E MOISTURE CONTENT BY AREA – CANADA

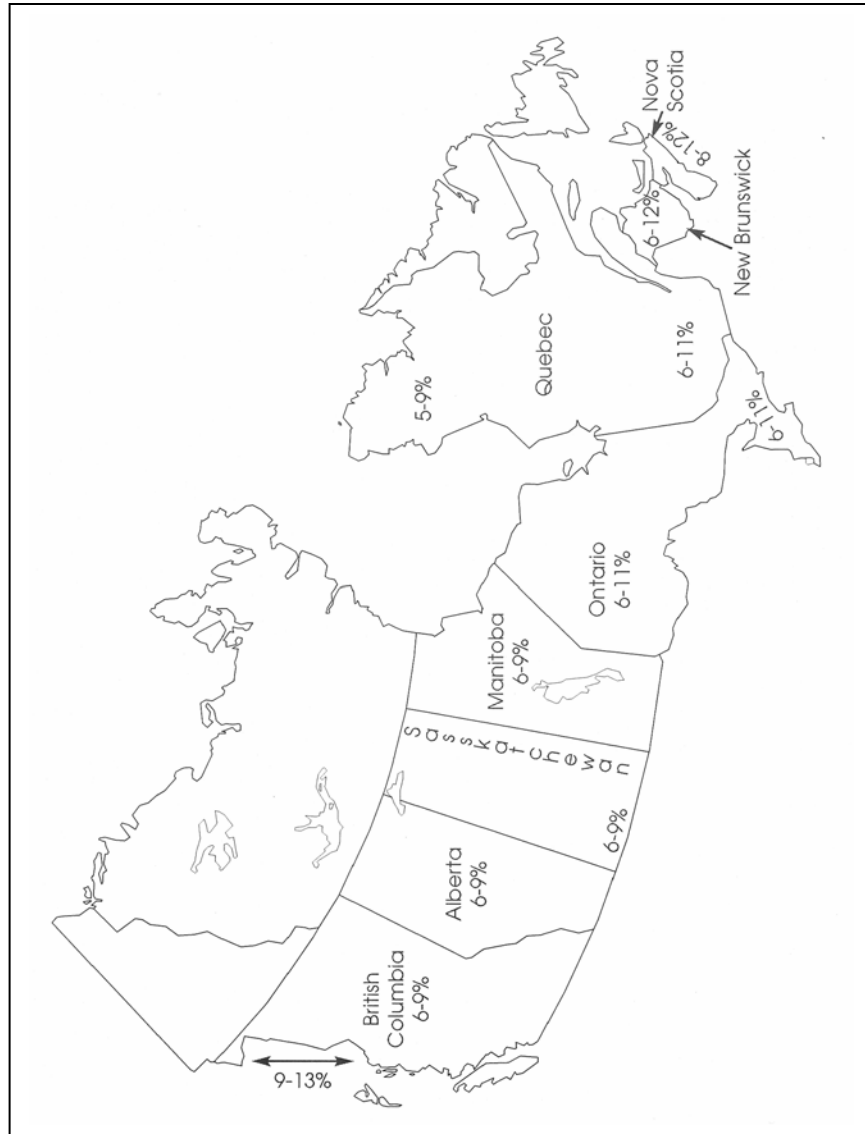

NOTE: Relative humidity in the building should be maintained at between 30-50 percent year-round.  
A consistent interior climate environment is the key to optimum wood flooring performance.

# APPENDIX F

## FASTENER SCHEDULE

Hardwood flooring must be installed over a proper subfloor. Tongue and grooved flooring MUST be blind nailed.

Wood Flooring Type	Fastener to be used	Fastener spacing
Solid Strip T&G ¾" x less than 3"	1½"-2" fastener, or 6d-8d casing or finish nails. On slab with ¾" underlayment, use 1½" fastener	Blind fastener spacing along the lengths of the strips, minimum two fasteners per piece near the ends (1-3"). In addition, every 8-10" apart for blind nailing, 10-12" for face nailing.
Solid Strip T&G ½" x 1½", ½" x 2"	1½" fastener	Blind fastener spacing along the lengths of the strips, minimum two fasteners per piece near the ends (1-3"). In addition, every 10" apart. ½" flooring must be installed over a minimum 5/8" thick subfloor.
Solid Strip T&G ⅜" x 1½", ⅜" x 2"	1¼" fastener	Blind fastener spacing along the lengths of the strips, minimum two fasteners per piece near the ends (1-3"). In addition, every 8" apart.
Solid Strip T&G 5/16"	Narrow crowned (under 3/8") 1"-1½" staples or 1"-1¼" hardwood flooring cleats.	Space fasteners at 3-4" intervals for staples, 4-6" for cleats, and within 1-2 inches of end joints, or as recommended by the flooring manufacturer.
Solid Plank ¾" x 3" or wider	1½"-2" fastener, or 6d-8d casing or finish nails. On slab with ¾" underlayment, use 1½" fastener	Blind fastener spacing along the lengths of the strips, minimum two fasteners per piece near the ends (1-3"). In addition, every 6-8" apart for blind nailing, 10-12" for face nailing. To assist the nailing schedule, options are to screw and plug the ends of each board, or to apply adhesive.
Engineered wood flooring	Narrow crowned (under 3/8") 1"-1½" staples or 1"-1¼" hardwood flooring cleats designed for engineered flooring.	Space fasteners at 3-4" intervals for staples, 4-6" for cleats, and within 1-2 inches of end joints, or as recommended by the flooring manufacturer.
Subfloor over concrete	Hardened steel pins, 11/4 – 21/8	Minimum of 50% of fastener must penetrate concrete. Space fasteners one per square foot or as recommended by the fastener manufacturer.

# APPENDIX G

## TRAMMEL POINT METHOD

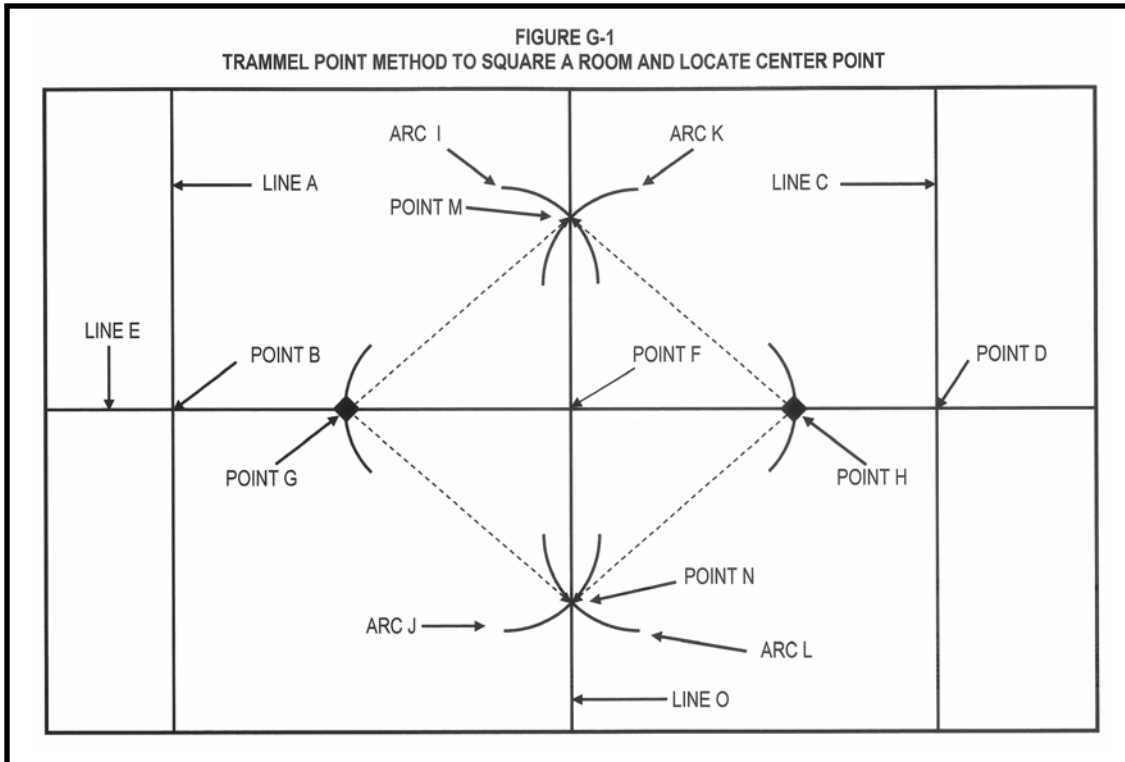

### Trammel Points

Trammel points, which are used to scribe a circle or radius, consist of two points mounted on a beam – typically a piece of wood – and designed to slide along the beam to increase or decrease the radius. Typically, one of the points is a pencil or pen, while the other is usually a metal point used to anchor the center of the circle or the radius. The size of the radius can be adjusted by sliding the marking point along the beam to the desired length and locking it into position.

### Trammel Point Method for Squaring a Room and Finding the Center

See Figure G-1

1. Measure the width of the room from top to bottom left of center (Line A).
2. Find the center of Line A and mark it (Point B).
3. Measure the width of the room from top to bottom right of center (Line C).
4. Find the center of Line C and mark it (Point D).

5. Adjust for any difference in center between Point B & Point D. For example, if Point B is one inch different than Point D, divide the difference by two to establish the new center point of Line A
6. Snap a line the length of the room from Point B through Point D. This is now Line E.
7. Find the center point of Line E and mark it Point F.
8. From Point F, use trammel point at fixed position on flat board to mark through Line E left of center, and mark it Point G.
9. From Point F, use trammel point at the same fixed position on flat board to mark through Line E right of center, and mark it Point H.
10. From Point G, use trammel point at a fixed position on flat board draw arc above Line E. Mark this Arc I.
11. From Point G, use trammel point at the same fixed position on flat board draw arc below Line E. Mark this Arc J.
12. From Point H, use trammel point at the same fixed position on flat board draw arc above Line E. Mark this Arc K.
13. From point H, use trammel point at the same fixed position on flat board draw arc below Line E. Mark this Arc L.
14. Where Arc I and Arc K intersect, mark it Point M.
15. Where Arc J and Arc L intersect, mark it Point N.
16. Snap a line from Point M through Point N, and mark it Line O.
17. Where Line O intersects Line E is the center of the room. Line E and Line O also form a 90-degree angle.

# APPENDIX H

## RADIANT HEAT INSTALLATIONS

With radiant heat, the heat source is directly beneath the flooring, so the flooring may dry out faster than a similar floor in a home with a conventional heating system. Wood flooring can be installed over radiant heat as long as you understand radiant heat and how it can impact wood flooring, what precautions to take, and what type of wood flooring to use.

Types of wood flooring that are best suited-for radiant heat subfloor are products that possess improved dimensional stability such as:

- Engineered wood flooring is more dimensionally stable than solid wood flooring.
- Certain species are known for their inherent dimensional stability such as North American oak, American cherry, American walnut and others. Denser species such as maple and Brazilian cherry are less stable.
- Quartersawn and rift-sawn wood flooring is more dimensionally stable in width than plain sawn wood flooring.
- Narrow boards are more dimensionally stable than wide boards.

### GENERAL RADIANT HEAT INSTALLATION GUIDELINES

- To minimize the effect that rapid changes in temperature will have on the moisture content of the wood floor, NWFA recommends that an outside thermostat be installed. If one is not present, suggest to your customer that this should be considered. Unlike conventional heating systems, which switch on as needed, radiant systems work most effectively and with less trauma to the wood floor if the heating process is gradual, based on small incremental increases in relation to the outside temperature.
- Subfloors should have proper moisture tests according to the moisture testing procedures outlined in Chapter 3.
- The essential requirement in proper applications of wood flooring over radiant heated systems is to avoid penetration of the heating element. Radiant-heated subfloor systems can be concrete, wood or a combination of both. The type of subfloor as described in the previous chapters determines subfloor preparation.
- If the subfloor is concrete and it has cured, turn the heat on, regardless of season, and leave it on for at least 5-6 days to drive out residual moisture before installation of the wood flooring. Some installation systems, particularly glue-down applications, require the heat to be reduced or even turned off before installation of the flooring begins, so the adhesive does not cure excessively.
- With water-heated radiant-heat systems, a pressure test must be performed and documented by a qualified plumber or the system installer prior to beginning the installation of the wood flooring.
- If flooring materials that conduct heat at different rates are on the same circuit or heating zone, check with the HVAC mechanical engineer before proceeding.

- Radiant heat is dry heat. A humidification system may be necessary to maintain wood flooring in its comfort zone.

The following installation and subfloor systems can be used successfully over radiant heat:

- 1. Glue-down, engineered or solid parquet
- 2. Floating engineered
- 3. Direct-nail, solid wood or engineered wood flooring to wood subfloor
- 4. Solid T&G floor direct-nail to sleepers
- 5. Single layer of plywood on sleepers
- 6. Double plywood floating subfloor
- 7. Loose-lay single layer of  $\frac{3}{4}$ " plywood cut in 16" planks staggered with  $\frac{1}{2}$ " gap between laid perpendicular to wood direction

## GLUE-DOWN, ENGINEERED OR SOLID PARQUET

**NOTE: Follow manufacturer's installation instructions.**

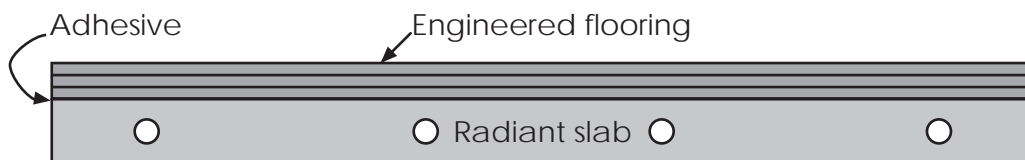

Install over approved subfloor. Refer to Chapter 7, Parquet Installation and Chapter 8, Engineered Flooring Installation.

- Use an adhesive approved by the manufacturer.
- The heating system has to be turned off before installation.
- The maximum allowable subfloor surface temperature is 85° F (29.44° C).
- Expect some heating season shrinkage.

## DIRECT NAIL, SOLID WOOD OR ENGINEERED TO WOOD SUBFLOOR

NOTE: Follow manufacturer's installation instructions.

- Install over approved subfloor. Refer to Chapter 8, Engineered Flooring Installation, and Chapter 9, Solid Strip & Plank Installation.
- Always check for subfloor moisture. See Chapter 3, Moisture Requirements and Moisture Testing.
- Solid wood must be properly acclimated to normal living conditions.
- All other installation procedures are the same as outlined in Chapter 8, Engineered Flooring Installation, and Chapter 9, Solid Strip & Plank Installation.
- Be sure fasteners are not so long as to penetrate heating elements.
- Maximum subfloor surface temperature-85° F (29.44° C).

### Direct Nail to Subfloor Over Joists

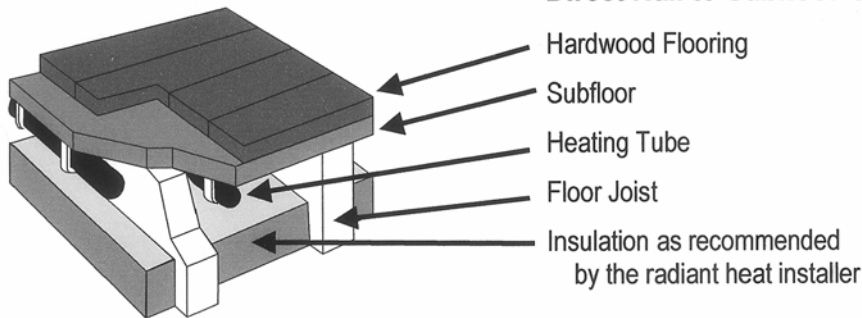

### Direct Nail to Subfloor Over Sleepers

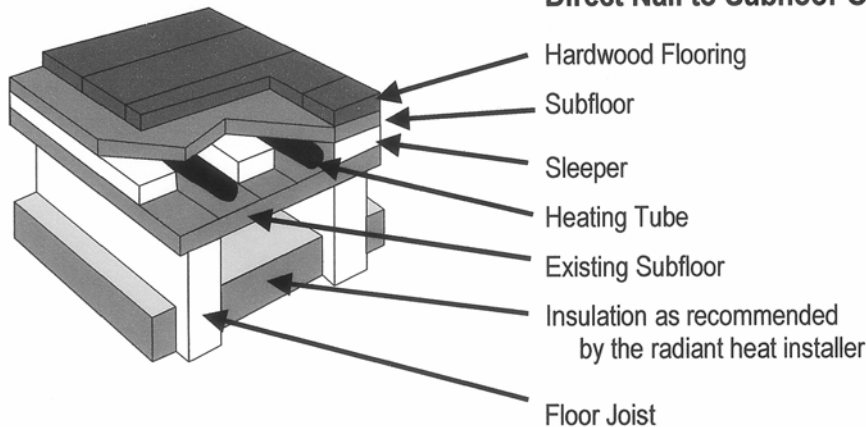



## SOLID T & G FLOOR DIRECT NAIL TO SLEEPERS

NOTE: Follow manufacturer's installation instructions.

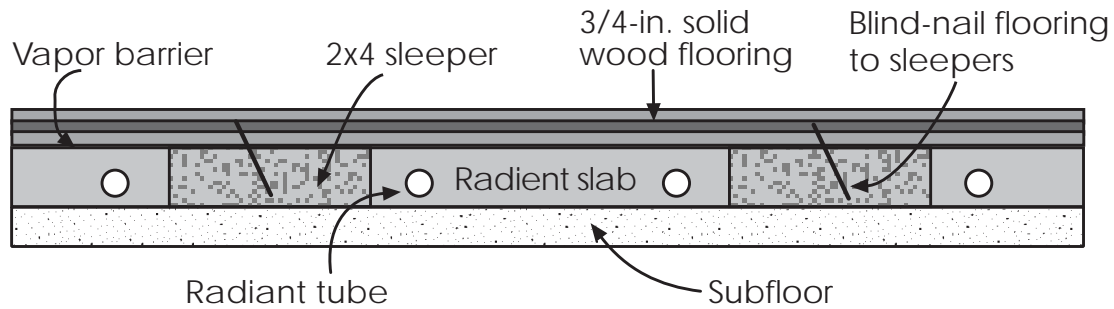

- The use of solid wood flooring 4 inches and wider is not recommended over sleepers.
- Solid wood must be properly acclimated.
- Cannot use shorts.
- Maximum subfloor surface temperature - 85° F (29.44° C)

## SINGLE LAYER OF PLYWOOD ON SLEEPERS

NOTE: Follow manufacturer's installation instructions.

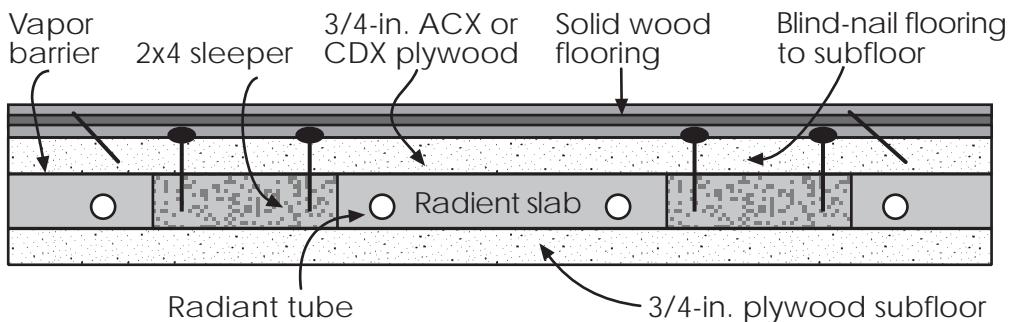

- Solid wood must be properly acclimated.
- Maximum subfloor surface temperature-85° F (29.44° C)

## DOUBLE PLYWOOD

NOTE: Follow manufacturer's installation instructions.

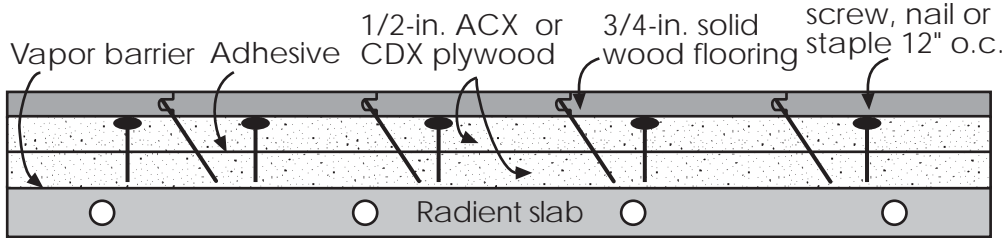

- Solid wood must be properly acclimated.
- Maximum subfloor surface temperature - 85° F (29.44° C)

## FLOATING ENGINEERED

NOTE: Follow manufacturer's installation instructions.

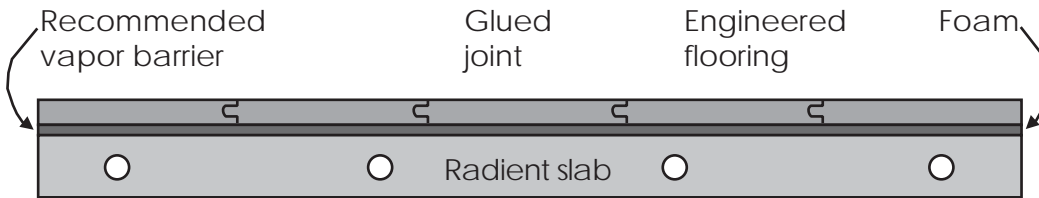

- Install over approved subfloor. Refer to Chapter 8, Engineered Flooring Installation.
- A 6 mil or better polyethylene vapor retarder should be installed over concrete subfloors. In some cases, this may be part of the flooring underlayment.
- A foam or resilient underlayment recommended by the flooring manufacturer must be installed prior to application of the wood flooring.
- Use an adhesive approved by the manufacturer for side and/or end joints.
- Maximum subfloor surface temperature-85° F (29.44° C).

# APPENDIX I

## INSTALLATION ON SCREEDS

- **NOTE: Solid  $\frac{3}{4}$ " and  $\frac{33}{32}$ " tongue-and-groove strip flooring may be installed directly to screeds.**
- **NOTE: Engineered wood flooring less than  $\frac{3}{4}$ " thick, thin-classification strip flooring (including  $\frac{1}{2}$ ") and solid plank flooring (4" or wider) cannot be installed directly to screeds.**
- For engineered flooring less than  $\frac{3}{4}$ " thick, thin-classification strip, and for solid plank (4" and wider), the screed system must be overlaid with proper subflooring. The screed system must be overlaid with  $\frac{23}{32}$ " (18.3mm) Exposure 1 plywood subfloor panels, or  $\frac{19}{32}$ " (15.1mm), Exposure 1 plywood subfloor panels or  $\frac{23}{32}$ " (18.3mm) OSB Exposure 1 underlayment properly spaced and oriented perpendicular to screed direction, and across two or more spans.

### Installation method:

#### **NOTE: THE FOLLOWING METHOD DOES NOT APPLY TO SCREED SYSTEMS OVER RADIANT HEAT**

- Abrade or scrape the concrete slab to ensure it is clean of paint, sheetrock mud and general construction residue and dry of moisture.
- Check slab for flatness with 6' minimum straight edge.
- Fill low areas or dips in slab with concrete underlayment compound.
- Break out or grind down concentrated high areas of slab.
- Pour hot tar (where building codes allow) or a urethane adhesive to cover the slab completely.
- Install short lengths (approximately 24") of 2x4 or 1x4 screeds in the hot tar or urethane adhesive, perpendicular to the direction of the flooring. Screeds should be placed on approximately 6" to 7" centers, to provide approximately 50% coverage. Screed joints should be staggered, easily accomplished by alternating full and half pieces on the starter wall. NOTE: Treated screeds are preferred only if they are kiln dried after treatment (KDAT). Otherwise, yellow pine, fir or other kiln dried framing species is acceptable. With treated screeds, stainless-steel fasteners are required.
- Allow adequate time for the tar or adhesive to properly cure.
- Check screeds for flatness with 6' minimum straight edge.
- Sand or plane the high areas of the screeds. Shim the low areas of the screeds with your preferred shimming material. Masonite or thin layers of plywood work well. Sand or plane shims to feather out transitions.
- Cover screeds with an impermeable vapor retarder, such as 6-mil poly membrane.
- Rack out flooring.

# APPENDIX J

## SOUND CONTROL

When installing wood floors (hard surface flooring) in multi-family dwellings it is necessary to take into consideration both the UBC and NBC requirements. The UBC Uniform Building Code and the BOCA National Building Code both have requirements regarding sound control for multi-family dwellings. Areas of the country that do not follow either of these code standards may have local building code regulations with their own sound control requirements. The BOCA National Building Code, 1996 has the following section for sound control:

1214.2 Air-borne noise: Walls, partitions and floor/ceiling assemblies separating dwelling units from each other or from public service areas shall have a sound transmission class (STC) of not less than 45 for air-borne noise when tested in accordance with ASTM E-90 listed in Chapter 35. This requirement shall not apply to dwelling unit entrance doors; however, such doors shall be tight fitting to the frame and sill. 1214.3 Structure borne sound: Floor/ceiling assemblies between dwelling units or between a dwelling unit and a public service area within the structure shall have an impact insulation class (IIC) rating of not less than 45 when tested in accordance with ASTM E-492 listed in Chapter 35.

Condominium associations may have a set of protective covenants with even more stringent regulations than the Uniform or National Building Code. The STC Sound Transmission Class is a laboratory measurement of the ability of a specific construction assembly (such as partition, window, door, etc) to reduce airborne sounds including voice, television and alarm clocks.

The IIC Impact Insulation Class is a laboratory measurement of the ability of a floor/ceiling assembly to reduce impact sound such as footfalls, movement of furniture etc.

The F-IIC rating is a field measurement done in situ after a floor installation is completed. The higher the value of any of the quantities above, the greater the airborne or impact isolation provided by the assembly.

In any building a sound rated flooring system, when properly installed, will significantly improve the IIC/FIIC when compared with a non-rated hard surface floor system. The sound rated flooring products do not have a significant effect on the STC measurement.

### Sound Control Product Types

There are a wide variety of materials that are marketed for their noise control properties. Some are systems, and others are specific materials. Noise transfer from floor to ceiling is dependent upon the entire floor ceiling assembly.

When comparing the performances in sound control products, only products with testing from a certified laboratory should be considered. Copies of the test should be requested so that variables can be closely compared. Variables, such as type of floor (i.e. wood or ceramic, laminate, marble), concrete thickness, with or without suspended ceiling, wood frame structure can greatly affect the performance or lack there of, of the product. Comparing products with similar variables make it easier to see which product performs better.

Sound control materials sold with F-IIC ratings (field tests) may not be accurate if all floor and ceiling construction is not included in the test.



## Installation

Product installation varies by product and manufacturer. One basic key to peak performance is to avoid hard surface transference points. This would mean that the floor should not come in direct contact with the wall or the molding. A small gap should be left between the molding and the floor as well as the floor and the wall. Leaving a gap would prevent sound from traveling across the floor to the wall or molding and down behind the wall where there is no sound control.

Nails are also considered a hard surface transference point. When installing a nail down wood floor nails should not penetrate through the floor and into the sound control material and sub floor below. Doing so would greatly diminish the performance of the sound control material.

# APPENDIX K

## TRIM & THRESHOLDS

### MOLDINGS USED WITH HARDWOOD FLOORS

Wood floors require expansion space at the wall and all vertical obstructions. Moldings are used to cover the expansion area, to hide cut ends, to adjust height differences or transitions between floors and to aesthetically finish the area. Profiles are many and vary through the industry. Here are some examples of standard profiles.



Baseboard



Baseshoe



Quarter Round



Reducer



Threshold/Saddle

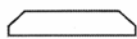

Baby Threshold

- **BASEBOARD** -- from 3/8" and thicker, from 1 1/2" and higher used to protect the wall and cover expansion space.

- **BASE SHOE** -- from 3/8" to 5/8" thick, from 1/2" to 1" high; used instead of baseboard or with baseboard to on vertical surfaces/bases to complete expansion coverage; flexible enough to conform to irregular surfaces.

- **QUARTER ROUND** -- one quarter of a full round; from 1/2" to 1"; used as an alternative to base shoe in some area.

- **REDUCER** -- from 5/16" to 3/4" thick, 1" to 3 1/2"+ wide; used to make transition in thickness from wood floor down to thinner surface, generally through door openings. Also used to cover expansion space around vertical surfaces such as fireplace hearths when mounted directly to surface of flooring.

- **THRESHOLD** -- from 5/16" to 3/4" thick, many widths; used to make the transition at doorways, between interior rooms and to the outside. Can be custom milled to any size.

- **BABY THRESHOLD** – often variable in thickness– used to cover expansion space in perimeter areas where vertical molding cannot be used, and to transition to thicker material, such as carpet. Example: Stone, brick wall and hearths as well as floor to ceiling glass and sliding doors. May also be used at existing door thresholds.

- **T-MOLDINGS** -- 5/8" thick by 2" wide, beveled down on both sides with a T-configuration used for transition from one hard surface floor to another.

- **CUSTOM MOLDINGS** - Moldings created for unusual circumstances may be manufactured to job site requirements to complement the wood floor and allow for proper transition and coverage of expansion space.



T-Moldings

## STAIRS/STEPS

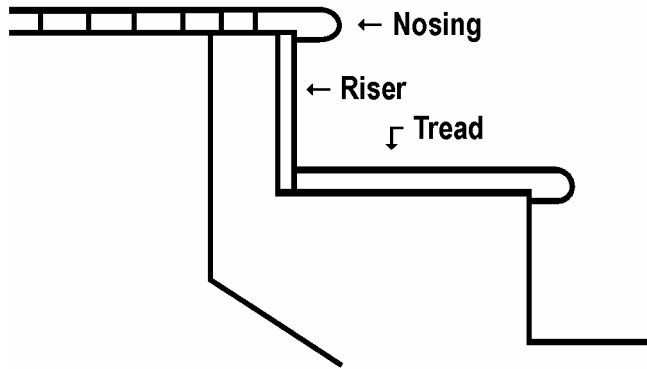

- **STAIR RISER** -- 3/4" thick, various heights and lengths, used to create the vertical "rise" in the step.
- **STAIR TREAD** -- 3/4" to 1 1/16" thick, various widths and lengths. It is the actual step surface.
- **NOSING** -- also called stair nosing, bull nose, stairwell trim, landing tread. Thickness same as flooring. Used to create finished edge on top step, around stairwell, sunken living room, etc.

# APPENDIX L

## SAMPLE SPECIFICATION

### For format purposes only

#### PART 1 – GENERAL

##### 1.1 SUMMARY

###### A. Section includes:

1. Solid strip wood flooring

##### 1.2 SUBMITTALS

###### A. Product Data: For each type of product indicated

###### B. Shop Drawings: Show installation details, including location and layout of each type of wood and accessory.

###### C. Samples: For each type of wood and accessory, with stain color and finish required, approximately 12 inches long and of same thickness and material indicated for the work. Include sample sets showing full range of normal color and texture variations expected.

##### 1.3 QUALITY ASSURANCE

###### A. Installer Qualifications: An experienced installer who has completed wood flooring work similar in material, design and extent to that indicated for this project, and whose work has resulted in wood flooring installations with a record of successful in-service performance.

###### B. Source Limitations: Obtain each type of material and product from one source with resources to provide materials and products of consistent quality in appearance and physical properties.

##### 1.4 DELIVERY, STORAGE AND HANDLING

###### A. Deliver wood materials in unopened cartons or bundles.

###### B. Protect wood from exposure to moisture. Do not deliver wood flooring until after concrete, masonry, plaster, ceramic tile and similar wet-work is completed and dry.

###### C. Store wood materials in dry, warm, well-ventilated, weather-tight location

##### 1.5 PROJECT CONDITIONS

###### A. Conditioning: Maintain relative humidity planned for building occupants, and an ambient temperature between 65° and 75° Fahrenheit in spaces to receive wood flooring for at least seven days before installation, during installation and for at least seven days after installation. After post-installation period, maintain relative humidity and ambient temperature planned for building occupants.

1. For unfinished products, open sealed packages to allow wood flooring to acclimatize.



2. Do not install wood flooring until it adjusts to the relative humidity of and is at the same temperature as the space where it is to be installed.
  3. Close spaces to traffic during flooring installation and for time period after installation recommended in writing by flooring and finish manufacturers.
- B. Install factory-finished wood flooring after other finish operations, including painting, have been completed.

#### 1.6 WARRANTY

- A. Warranty: Provide manufacturer's standard warranty in which manufacturer agrees to replace materials defective in quality and workmanship.

#### 1.7 EXTRA MATERIALS

- A. Furnish extra materials described below, before installation begins, that match products installed and that are packaged with protective covering for storage and identified with labels describing contents.

1. Wood Flooring: Equal to 1 percent of amount installed for each type and finish indicated.

### PART 2 - PRODUCTS

#### 2.1 WOOD FLOORING

- A. Wood Material: As indicated in Interior Drawings & Specifications.
- B. Finish System: Water-borne urethane floor finish as approved by flooring manufacturer and as required to achieve desired finish to match customer's sample.

#### 2.1 ACCESSORY MATERIALS

- A. Wood Flooring Adhesive: Adhesive recommended by flooring and adhesive manufacturer for application indicated.
- B. Fasteners: As recommended by manufacturer, but not less than that recommended by the National Wood Flooring Association's "Installation Guidelines and Methods."
- C. Vapor retarder: As required by subfloor conditions and local building codes.

### PART 3 - EXECUTION

#### 3.1 EXAMINATION

- A. Examine substrates, areas and conditions, with installer present, for compliance with requirements, installation, tolerances and other conditions affecting performance of wood flooring. Proceed with installation only after unsatisfactory conditions have been corrected.
- B. Concrete Slabs: Verify that concrete slabs comply with requirements specified by flooring manufacturer or, if none, by test methods specified in the National Wood Flooring Association's "Installation Guidelines and Methods."

#### 3.2 INSTALLATION

- A. General: Comply with flooring manufacturer's written instructions and recommendations by the National Wood Flooring Association's "Installation Guidelines and Methods," as applicable to flooring type.

- B. Pattern: Lay wood flooring in pattern indicated in drawings or, if not indicated, as directed by Interior Designer, Architect or Owner.
- C. Flooring: Install using one of the following methods, as approved by Interior Designer, Architect or Owner:
  - 1. Blind nail flooring to substrate according to methods specified in the National Wood Flooring Association's "Installation Guidelines and Methods.
  - 2. Glue flooring to substrate as recommended by wood flooring manufacturer.
  - 3. Expansion Space: Provide expansion space at walls and other obstructions and terminations of wood flooring of not less than ½ inch, unless otherwise indicated on drawings
    - a. Unless fully concealed by trim, fill expansion space with flush cork expansion strip.

### 3.3 SANDING AND FINISHING

- A. Apply finish according to finish manufacturer's written instructions. Apply the number of coats recommended by finish manufacturer for application indicated.
- B. For water-based finishes, use finishing methods recommended by finish manufacturer to minimize grain raise.

### 3.4 PROTECTION

- A. Fully cover installed flooring to protect it from damage or deterioration, before and after finishing, and during remainder of construction period. Use building paper or other suitable covering. Do not use plastic sheet or film that could cause condensation. Do not tape covering to finished flooring.
  - 1. Do not cover site-finished floors until finish reaches full-cure, but not less than seven days after applying last coat.

# APPENDIX M

## JOBSITE CHECKLIST

(Also see Chapter 1, Jobsite Conditions)

One primary rule will eliminate many potential problem-causing jobsite conditions: Wood flooring should be one of the last jobs completed on any construction project. In particular, the jobsite should be enclosed and climate-controlled before wood flooring is delivered or installed. In addition, other trades working on the jobsite can damage the wood flooring installation, so many problems can be minimized by limiting the amount of traffic at the jobsite after the wood flooring is installed.

Certainly the jobsite should be carefully evaluated for potential problems before installation begins, but a thorough site evaluation should also be done even before wood flooring is delivered to the jobsite.

The reprintable Jobsite Checklist on the following pages can be used on the jobsite.

# JOBSITE CHECKLIST

<b>I. GENERAL INFORMATION</b>	
Owner's Name _____	Date _____
Address _____	
Home phone _____	
Husband's work phone _____	Wife's work phone _____
Cellular/car phone _____	Pager _____
Jobsite address _____	
Jobsite visit appointment date _____	Time _____

## **II. TYPE OF JOB**

Residential \_\_\_\_\_ Commercial \_\_\_\_\_  
 New \_\_\_\_\_ Remodel \_\_\_\_\_

## **III. RESIDENTIAL USE INFORMATION**

Traffic High \_\_\_\_\_ Average \_\_\_\_\_ Low \_\_\_\_\_  
 Any special or unique use \_\_\_\_\_  
 Project rooms/areas \_\_\_\_\_  
 Project budget \_\_\_\_\_

## **IV. COMMERCIAL USE INFORMATION**

Retail store \_\_\_\_\_ Restaurant \_\_\_\_\_ Office \_\_\_\_\_  
 Bar \_\_\_\_\_ Other \_\_\_\_\_  
 Traffic High \_\_\_\_\_ Average \_\_\_\_\_ Low \_\_\_\_\_  
 High-rise Yes \_\_\_\_\_ No \_\_\_\_\_  
 Freight elevator Yes \_\_\_\_\_ No \_\_\_\_\_  
 Passenger elevator Yes \_\_\_\_\_ No \_\_\_\_\_  
 Hours of access \_\_\_\_\_  
 Power access \_\_\_\_\_  
 Maintenance \_\_\_\_\_  
 Maintenance company \_\_\_\_\_  
 Phone \_\_\_\_\_  
 Proximity of parking \_\_\_\_\_  
 Cost of parking \_\_\_\_\_

## **V. INTERIOR**

Relative humidity in air-space:  
 Hygrometer \_\_\_% Sling psychrometer \_\_\_%  
 HVAC units operable Yes \_\_\_\_\_ No \_\_\_\_\_  
 If, no, date to be operating \_\_\_\_\_  
 Type of heat: \_\_\_\_\_  
 Radiant \_\_\_\_\_ Baseboard \_\_\_\_\_ Radiator \_\_\_\_\_  
 Forced Air \_\_\_\_\_ Electric \_\_\_\_\_ Gas \_\_\_\_\_  
 Wood-burning stove Heat ducts \_\_\_\_\_  
 Overhead \_\_\_\_\_ Under floor \_\_\_\_\_

Insulated Yes \_\_\_\_\_ No \_\_\_\_\_

Humidity controls Yes \_\_\_\_\_ No \_\_\_\_\_

Thermostat setting  
 First unit \_\_\_\_\_ F Second Unit \_\_\_\_\_ F

Air conditioning Yes \_\_\_\_\_ No \_\_\_\_\_

Large window/sliding glass doors facing:  
 East \_\_\_\_\_ South \_\_\_\_\_ West \_\_\_\_\_

Drapes Yes \_\_\_\_\_ No \_\_\_\_\_

Tinted glass Yes \_\_\_\_\_ No \_\_\_\_\_

Double-glazed/  
 storm windows Yes \_\_\_\_\_ No \_\_\_\_\_

### **KITCHEN:**

Instant hot water Yes \_\_\_\_\_ No \_\_\_\_\_

Refrigerator Yes \_\_\_\_\_ No \_\_\_\_\_

Icemaker Yes \_\_\_\_\_ No \_\_\_\_\_

Food freezer Yes \_\_\_\_\_ No \_\_\_\_\_

Dishwasher Yes \_\_\_\_\_ No \_\_\_\_\_

Other \_\_\_\_\_

### **MUD ROOM/LAUNDRY ROOM:**

Clothes dryer  
 vented outside Yes \_\_\_\_\_ No \_\_\_\_\_

Plumbing leaks \_\_\_\_\_

Ceiling stains \_\_\_\_\_

### **BATHROOM**

Bathroom exhaust Yes \_\_\_\_\_ No \_\_\_\_\_

Heated exhaust Yes \_\_\_\_\_ No \_\_\_\_\_

### **BASEMENT**

Walls cracked Yes \_\_\_\_\_ No \_\_\_\_\_

Paint peeling Yes \_\_\_\_\_ No \_\_\_\_\_

Floor stained Yes \_\_\_\_\_ No \_\_\_\_\_

Damp Yes \_\_\_\_\_ No \_\_\_\_\_

Vented Yes \_\_\_\_\_ No \_\_\_\_\_

Rusty nails Yes \_\_\_\_\_ No \_\_\_\_\_



Sump pump Yes \_\_\_\_\_ No \_\_\_\_\_  
 Condensation on cold-water lines Yes \_\_\_\_\_ No \_\_\_\_\_  
 Musty smell Yes \_\_\_\_\_ No \_\_\_\_\_  
 Heated Yes \_\_\_\_\_ No \_\_\_\_\_  
 Air-conditioned Yes \_\_\_\_\_ No \_\_\_\_\_  
 Relative humidity in air-space:  
 Hygrometer \_\_\_% Sling psychrometer \_\_\_%

**VI. EXTERIOR**

Building is over  
 Basement \_\_\_ Crawl space \_\_\_ Slab \_\_\_  
 Relation of lot to street  
 Above \_\_\_ Level \_\_\_ Below \_\_\_  
 Lot cut and fill Yes \_\_\_\_\_ No \_\_\_\_\_  
 Relation of lot to neighbor  
 Above \_\_\_ Level \_\_\_ Below \_\_\_  
 Lot drainage away from foundation  
 Yes \_\_\_\_\_ No \_\_\_\_\_  
 Shaded Lot Yes \_\_\_\_\_ No \_\_\_\_\_  
 Gutters/downspouts Yes \_\_\_\_\_ No \_\_\_\_\_  
 Directed away Yes \_\_\_\_\_ No \_\_\_\_\_  
 Roof overhang Yes \_\_\_\_\_ No \_\_\_\_\_  
**Foundation perimeter**  
 Waterproof Yes \_\_\_\_\_ No \_\_\_\_\_  
 Soil damp Yes \_\_\_\_\_ No \_\_\_\_\_  
 Window wells-dry Yes \_\_\_\_\_ No \_\_\_\_\_  
 Planterbox Yes \_\_\_\_\_ No \_\_\_\_\_  
 Shrubs/flowers Yes \_\_\_\_\_ No \_\_\_\_\_  
 Comments \_\_\_\_\_  
 Yard established Yes \_\_\_\_\_ No \_\_\_\_\_  
 Recent Yes \_\_\_\_\_ No \_\_\_\_\_  
 Sprinklers/irrigation Yes \_\_\_\_\_ No \_\_\_\_\_  
 Excess Watering Yes \_\_\_\_\_ No \_\_\_\_\_  
 Entry is:  
 Step up \_\_\_ Level \_\_\_ Down \_\_\_  
 Swimming pool Yes \_\_\_\_\_ No \_\_\_\_\_  
 In-ground \_\_\_ Above-ground \_\_\_  
 Distance from pool to foundation \_\_\_\_\_ feet  
 Drains in pool deck and/or patio Yes \_\_\_\_\_ No \_\_\_\_\_  
 Is street curb drain active Yes \_\_\_\_\_ No \_\_\_\_\_  
**CRAWL SPACE:**  
 Distance from soil to subfloor \_\_\_\_\_  
 Condensation Yes \_\_\_\_\_ No \_\_\_\_\_  
 Musty Smell Yes \_\_\_\_\_ No \_\_\_\_\_  
 Concrete Slab Yes \_\_\_\_\_ No \_\_\_\_\_

Moisture barrier beneath concrete Yes \_\_\_\_\_ No \_\_\_\_\_  
 Dirt floor Yes \_\_\_\_\_ No \_\_\_\_\_  
 6- or 8- mil black poly cover over dirt Yes \_\_\_\_\_ No \_\_\_\_\_  
 15sf open vent per 1,000sf floor area Yes \_\_\_\_\_ No \_\_\_\_\_  
 Vents open Yes \_\_\_\_\_ No \_\_\_\_\_  
 Cross-ventilation Yes \_\_\_\_\_ No \_\_\_\_\_

**VII. SUBFLOOR INFORMATION**

*(Reference NWFA Installation Guidelines, Section 2, Chapter 2-7 for approved subfloor.)*  
 Existing Wood type:  
 3/4-inch CDX plywood \_\_\_\_\_  
 5/8-inch CDX plywood \_\_\_\_\_  
 23/32-inch OSB underlayment grade \_\_\_\_\_  
 Solid board \_\_\_\_\_  
 Other \_\_\_\_\_  
 Renail Yes \_\_\_\_\_ No \_\_\_\_\_  
 Sand Yes \_\_\_\_\_ No \_\_\_\_\_  
 Damage Yes \_\_\_\_\_ No \_\_\_\_\_  
 Pet stains Yes \_\_\_\_\_ No \_\_\_\_\_  
 Rot Yes \_\_\_\_\_ No \_\_\_\_\_  
 Other subfloor repair \_\_\_\_\_  
 Average moisture content in flooring \_\_\_\_\_%  
 Average moisture content in subfloor \_\_\_\_\_%  
 Average moisture content in sleepers \_\_\_\_\_%  
 Average moisture content in joists \_\_\_\_\_%  
 In areas or seasons of extreme moisture conditions, check moisture content in:  
 Adjacent baseboard \_\_\_\_\_%  
 Door trim \_\_\_\_\_%  
 Wood threshold \_\_\_\_\_%  
 Paint/finish lines exposed Yes \_\_\_\_\_ No \_\_\_\_\_  
 Trim pieces dislodged Yes \_\_\_\_\_ No \_\_\_\_\_  
**SLAB:**  
 Relate elevation of slab surface to exterior soil line +/- \_\_\_\_\_ inches  
 Slab tested for moisture before install  
 Yes \_\_\_\_\_ No \_\_\_\_\_  
 What test \_\_\_\_\_  
 Results \_\_\_\_\_  
 New slab \_\_\_\_\_ Date poured \_\_\_\_\_  
 Existing slab \_\_\_\_\_ Age \_\_\_\_\_  
 Float/grind slab Yes \_\_\_\_\_ No \_\_\_\_\_  
 Install wood subfloor Yes \_\_\_\_\_ No \_\_\_\_\_  
 Moisture membrane Yes \_\_\_\_\_ No \_\_\_\_\_

**VI. FLOORING TYPES**

Unfinished \_\_\_\_\_ Prefinished \_\_\_\_\_  
 Species \_\_\_\_\_  
 Size of flooring desired \_\_\_\_\_  
 Solid \_\_\_\_\_ Engineered \_\_\_\_\_ Floating floor \_\_\_\_\_  
 Strip \_\_\_\_\_ Plank \_\_\_\_\_ Parquet \_\_\_\_\_

**INSTALLATION:**

Glued \_\_\_\_\_ Stapled \_\_\_\_\_ Nailed \_\_\_\_\_  
 Stain color \_\_\_\_\_  
 Sealer \_\_\_\_\_  
 Finish \_\_\_\_\_  
 Number of coats \_\_\_\_\_  
 Trim and moldings \_\_\_\_\_  
 Special layout Yes \_\_\_\_\_ No \_\_\_\_\_  
 If yes, type \_\_\_\_\_

**IX. SPECIAL REQUIREMENTS**

**NEW CONSTRUCTION:**

Power 110 \_\_\_\_\_ 220 \_\_\_\_\_  
 Distance to pole \_\_\_\_\_  
 Booster Yes \_\_\_\_\_ No \_\_\_\_\_  
 Time schedule for installation \_\_\_\_\_  
 Other trades \_\_\_\_\_  
 Wet work completion \_\_\_\_\_

**REMODEL:**

Move furniture Yes \_\_\_\_\_ No \_\_\_\_\_

**Special Needs**

Piano \_\_\_ Antiques \_\_\_ Appliances \_\_\_\_  
 Toilet \_\_\_ Other \_\_\_\_\_

(Note: Gas and water lines must be disconnected by customer or qualified personnel.)

Company responsible \_\_\_\_\_  
 Phone \_\_\_\_\_

**Existing floor covering**

Carpet \_\_\_\_\_ Sheet vinyl \_\_\_\_\_  
 Vinyl tile \_\_\_\_\_ Ceramic tile \_\_\_\_\_  
 Wood \_\_\_\_\_ Other \_\_\_\_\_

**Do existing wall moldings**

need to be removed Yes \_\_\_\_\_ No \_\_\_\_\_

**Does the existing floor covering need**

to be removed Yes \_\_\_\_\_ No \_\_\_\_\_

*Note: If it appears that floor covering could contain asbestos, check with the dealer/contractor company for proper abatement procedures.*

Who is responsible for removal of existing floor covering? \_\_\_\_\_

Who is responsible for trash disposal? \_\_\_\_\_

**Use graph paper like that below to sketch the dimensions of the installation to scale.**

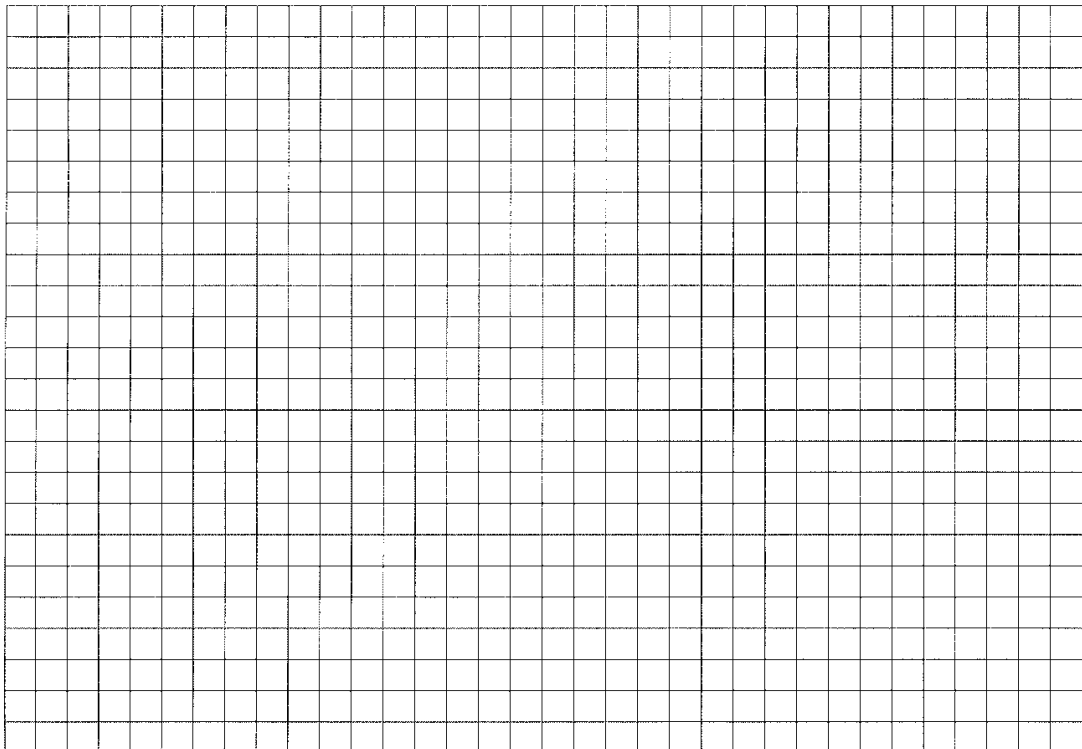



# SECTION V

## GLOSSARY OF

### WOOD FLOORING TERMS

# GLOSSARY OF WOOD FLOORING TERMS

**Abrasion Resistance** That property of a surface that resists being worn away by a rubbing or friction process. Abrasion resistance isn't necessarily related to hardness, as believed by some, but is more closely comparable to, or can be correlated with, toughness.

**Acclimation** The act of allowing wood moisture content to become at equilibrium with the environment in which it will perform. (See EMC, Equilibrium Moisture Content)

**Acid** Chemical substance rated below 7 on the PH scale.

**Air-Dried** Dried by exposure to air in a yard or shed without artificial heat. (Not kiln dried)

**Alkalinity** A measurement of an alkaline rating about 7 on the PH scale.

**Annual Growth Ring** The layer of wood growth formed on a tree during a single growing season.

**Asphalt Saturated Felt Paper** A #15 asphalt felt paper that meets ASTM Standard D-4869 or asphalt laminated paper that meets federal specification UU-B-790a Grade B, Type I, Style 1a, or asphalt saturated paper that meets federal specification UU-B-790a, Grade D, Type I, Style 2. Commonly used as a vapor retarder.

**ASTM** (American Society for Testing and Materials) develops and publishes voluntary technical standards for a wide range of materials, products, systems, and services. ASTM uses a consensus process involving technical committees that draw their members from around the world. ASTM International has no role in requiring or enforcing compliance with its standards, but in many instances its standards have been adopted by rules-making industry and governmental bodies.

**ASTM F-2170** Standard Test Method for Determining Relative Humidity in Concrete Floor Slabs Using In Situ Probes.

**ASTM F-1869** Test Method for Measuring Moisture Vapor Emission Rate of Concrete Subfloor Using Anhydrous Calcium Chloride.

**ASTM (modified) D-4944-043.** Calcium Carbide (CM) Test.

**Base Shoe** A molding designed to be attached to baseboard molding to cover expansion space. It is the alternative to a quarter-round in profile.

**Bastard Sawn** See Rift Sawn.

**Beveled Edge** The chamfered or beveled edge of wood flooring, plank, block and parquet.

**Board Foot** A unit of measurement of lumber represented by a board 1 foot long, 12 inches wide and 1 inch thick or its cubic equivalent. In practice, the board foot calculation for lumber 1 inch or more in thickness is based on its nominal thickness and width and the actual length. Lumber with a nominal thickness of less than 1 inch is calculated as 1 inch.

**Borders** Simple or intricate designs which frame and customize a flooring installation.



**Bow** The distortion of lumber in which there is a deviation, in a direction perpendicular to the flat face, from a straight line from end to end of the piece.

**Burl** A swirl or twist of the grain of the wood that usually occurs near a knot, but doesn't contain a knot, commonly found in the stump of a tree and where limbs branch out from the tree.

**Chatter Marks** Slight, closely spaced indentations causing a ripple effect on the surface of a wood floor.

**Check** A lengthwise separation of the wood that usually extends across the rings of annual growth.

**Checking (finish)** Similar to alligatoring, except that the finish is broken into smaller segments. Crowfoot checking is the name given to the defect when the breaks in the film form a definite three-prong pattern with the breaks running outward from a central point of intersection. When the checks are generally arranged in parallel lines, the defect is known as line checking. Irregular checks without a definite pattern are known as irregular checking.

**Cleat** A barbed fastener commonly used as a mechanical device to fasten hardwood flooring.

**Color Change** Visual changes in the color of the wood species caused by exposure to light, deprivation of light and air, or some chemical reaction.

**Compression Set** Caused when wood strips or parquet slats absorb excess moisture and expand so much that the cells along the edges of adjoining pieces in the floor are crushed. This causes them to lose resiliency and creates cracks when the floor returns to its normal moisture content.

**Coniferous** See Softwoods.

**Crook** The distortion of a board in which there is a deviation, in a direction perpendicular to the edge, from a straight line from end to end of the piece.

**Cross Directed** Laying of material perpendicular to the material below it.

**Crowning** A convex or crowned condition or appearance of individual strips with the center of the strip higher than the edges. The opposite of cupping.

**Cupping** A concave or dished appearance of individual strips with the edges raised above the center. The opposite of crowning.

**Deciduous** See Hardwoods.

**Deformed fasteners** Fastener in which the sides are not smooth and the head shape may be irregular. Examples are ring-shank and screw-shank nails.

**Delamination** The separation of layers in an engineered wood floor, through failure within the adhesive or between plies. Also between layers of stain and/or coating.

**Diffuse-Porous Woods** Certain hardwoods in which the pores tend to be uniform in size and distribution throughout each annual ring or to decrease in size slightly and gradually toward the outer border of the annual growth ring. Hard maple is an example.

**Dimensional Stability** The ability to maintain the original intended dimensions when influenced by a foreign substance. Wood is hygroscopic (readily takes up moisture) and isn't dimensionally stable with changes in moisture content below the fiber saturation point. Engineered wood flooring, however, is more dimensionally stable than solid wood.

**Distressed** A heavy artificial texture in which the floor has been scraped, scratched or gouged to give it a time-worn antique look.

**Drywall** Interior covering material (such as gypsum board, hardboard or plywood) that is applied in large sheets or panels.

**Durability** The ability of the wood species or finish to withstand the conditions or destructive agents with which it comes in contact in actual usage, without an appreciable change in appearance or other important properties.

**Eased Edge** See Beveled Edge.

**End Joint** The place where two pieces of flooring are joined together end to end.

**End Lifting** A swelling of the top layer of engineered wood flooring, occurring at an end joint.

**End-Matched** In tongue-and-groove strip and plank flooring, the individual pieces have a tongue milled on one end and a groove milled on the opposite end, so that when the individual strips or planks are butted together, the tongue of one piece fits into the groove of the next piece. See Side-Matched and Tongue-and-Grooved.

**Engineered** An assembly made by bonding layers of veneer or lumber with an adhesive so that most adjacent layers have their grains going in perpendicular directions to increase dimensional stability.

**Equilibrium Moisture Content (EMC)** The moisture content at which wood neither gains nor loses moisture when surrounded by air at a given relative humidity and temperature.

**Fading** The loss of color due to exposure to light, heat or other destructive agents.

**Feature Strip** A strip of wood used at a threshold or to border a room or to otherwise serve as an accent. Usually of a contrasting color or species.

**Fiberboard** A broad generic term inclusive of sheet materials of widely varying densities manufactured of refined or partially refined wood or other vegetable fibers. Bonding agents and other materials may be added to increase strength, resistance to moisture, fire or decay, or to improve some other property.

**Fiber Saturation Point** The stage in drying or wetting wood at which the cell walls are saturated with water and the cell cavities are free from water. It's usually taken as approximately 30 percent moisture content, based on over-dry weight.

**Figure** Inherent markings, designs or configurations on the surface of the wood produced by the annual growth rings, rays, knots and deviations from regular grain.

**Filler** In woodworking, any substance used to fill the holes and irregularities in planed or sanded surfaces to decrease the porosity of the surface before applying finish coatings. Wood filler used for cracks, knotholes and worm holes is often a commercial putty, plastic wood or other material mixed to the consistency of putty. A wood filler also may be mixed on the job using sanding dust from the final sanding, or other suitable material, mixed with a product appropriate for this use.

**Fillets** The small components that comprise finger-block parquet. Also called fingers or slats. Fillet may also refer to the top layer of some engineered wood flooring.

**Fingers** See Fillets.

**Finger-block** Parquet made from small strips of wood assembled together. See Fillets.

**Fire Resistance** the property of a material or assembly to withstand fire or given protection from it. Certain species naturally provide greater fire resistance than others. Classes are I-II-III or A-B-C with Class I or A being the most fire resistant.

**Fire Retardant** A chemical or preparation of chemicals used to reduce flammability or to retard the spread of a fire over a surface.

**Flag** A heavy dark mineral streak shaped like a banner.

**Flag Worm Hole** One or more worm holes surrounded by a mineral streak.

**Flame Spread** The propagation of a flame away from the source of ignition across the surface of a liquid or solid, or through the volume of a gaseous mixture. NOTE: Most wood species are Class C Flame Spread unless the wood floor has been treated and marked as to flame spread.

**Flecks** The wide irregular, conspicuous figure in quartersawn oak flooring. See **Medullary Rays**.

**Floating Floor** A floor that does not need to be nailed or glued to the subfloor. Typically, the flooring panels are connected together by adhesive or mechanical connectors.

**Flow** The characteristic of a coating that allows it to level or spread into a smooth film of uniform thickness before hardening.

**Graininess** The objectionable appearance of small, grain-like particles in a finishing material or in the dried film thereof.

**Hardened Steel Pin** Specialty fasteners designed to penetrate and hold concrete, steel and other substrates. Steel pins are typically installed with powder, pneumatic or gas-powered tools.”

**Hardness** That property of the wood species or dried film of finishing material that causes it to withstand denting or being marked when pressure is exerted on its surface by an outside object or force.

**Hardwood** Generally, one of the botanical groups of deciduous trees that have broad leaves, in contrast to the conifers or softwoods. The term has no reference to the actual hardness of the wood.

**Heartwood** The wood extending from the pith to the sapwood, the cells of which no longer participate in the life processes of a tree. It is usually darker than sapwood. See Pith and Sapwood.

**Heavy Streaks** Spots and streaks of sufficient size and density to severely mar the appearance of wood.

**Honeycombing** Checks often not visible at the surface that occur in the interior of a piece of wood, usually along the wood rays.

**Humidity** The amount of water vapor in the air. See Relative Humidity.

**Hygrometer** An instrument for measuring the degree of humidity or relative humidity of the atmosphere.

**Hygroscopic** A substance that can absorb and retain moisture, or lose or throw off moisture. Wood and wood products are hygroscopic. They expand with absorption of moisture and their dimensions become smaller when moisture is lost or thrown off.

**In Situ** A Latin term that means “in place” or “on site,” the term applies to testing done on site, or on materials in their original location, as opposed to testing done in a laboratory. Some sound-

control testing is done in the field or "in situ," and moisture testing of concrete slabs is often done using "in situ" probes.

**Intensity** The intensity of a color is its purity or degree of hue as seen by the eye.

**Jointed Flooring** Strip flooring, generally birch, beech, hard maple or pecan, manufactured with square edges, not side-matched, but usually end-matched. It is used principally for factory floors where the square edges make replacement of strips easier.

**Joist** One of a series of parallel beams used to support floor or ceiling loads and supported in turn by larger beams, girders or bearing walls.

**Kiln** (often pronounced "kill") A chamber having controlled air flow, temperature and relative humidity for drying lumber, veneer and other wood products.

**Kiln-Dried** Dried in a kiln with the use of artificial heat.

**Knot** The portion of a branch or limb that has been surrounded by subsequent growth of the stem. The shape of the knot as it appears on a cut surface depends on the angle of the cut relative to the long axis of the knot. In hardwood strip flooring, small and pin knots aren't more than one-half inch in diameter. A sound knot is a knot cut approximately parallel to its long axis so that the exposed section is definitely elongated.

**Manufacturing Defects** Includes all defects or blemishes that are produced in manufacturing, such as chipped grain, torn grain, skips in dressing, hit-and-miss (a series of surfaced areas with skips between them), variation in machining, machine burn, and mismatching.

**Mechanic** A flooring installer, sander or finisher.

**Medullary Rays** Strips of cells extending radially within a tree and varying in height from a few cells in some species to four or more inches in oak. The rays serve primarily to store food and transport it horizontally in the tree. On quartersawn oak, the rays form a conspicuous figure sometimes referred to as flecks. See Flecks.

**Mineral Spirits** A solvent product used as a thinner and/or cleaner.

**Mineral Streak** Wood containing an accumulations of mineral matter introduced by sap flow, causing an unnatural color ranging from greenish brown to black.

**Mixed Media** A wood floor that is predominately of wood, but also incorporates other materials, such as slate, stone, ceramic, marble or metal.

**Moisture Content** the amount of moisture in wood expressed as a percentage of the weight of oven-dried wood. National Oak Flooring Manufacturers Association hardwood flooring is manufactured at 6 to 9 percent moisture content, with a 5 percent allowance for pieces up to 12 percent moisture content. Five percent of the flooring may be outside of this range.

**Muratic Acid** A diluted acid used to neutralize alkalinity of concrete subfloors.

**Nailing Shoe (or Nailing Plate)** An attachment to a blind-nailing machine that broadens the impact area. Often required for fastening factory-finished flooring.

**Nominal Size** As applied to timber or lumber, the size by which it is known and sold in the market; often different from actual size.

**Nosing** A hardwood molding used to cover the outside corner of a step, milled to meet the hardwood floor in the horizontal plane, to meet the riser in the vertical plane. It is usually used on landings.

**OSB** Oriented Strand Board commonly used as an underlayment or subfloor material. Strands tend to be oriented with their length aligned with the panel length (typically). OSB is therefore stiffer and stronger when installed with the long axis across supports.

**Overwood/Underwood** A flooring condition in which there is a perceived misalignment of the flooring surface, with some wood pieces raised above adjacent pieces leaving a slightly uneven surface. Also called lippage.

**Parquet** A patterned floor.

**Particleboard** A generic term for a material manufactured from wood particles or other ligno-cellulosic material and a synthetic resin or other suitable binder. Flakeboard is a particle panel product composed of flakes. Oriented strand board is a type of particle panel product composed of strand-type flakes that are purposely aligned in directions that make a panel stronger, stiffer and with improved dimensional properties in the alignment directions than a panel of random flake orientation. Waferboard is a particle panel product made of wafer-type flakes. It is usually manufactured to possess equal properties in all directions parallel to the plane of the panel.

**Photo-sensitive** The property of some wood species which causes them to lighten or darken when exposed to light. See color change.

**Pin-Worm Hole** In hardwood flooring, a small round hole not more than 1/16-inch (1.5626MM) in diameter, made by a small wood-boring insect.

**Pith** The small, soft core occurring near the center of a tree trunk, branch, twig or log. First growth.

**Plain Sawn** The annual growth rings make an angle of less than 45° with the surface of the piece. This exposes the pores of the springwood and dense summerwood of the annual growth ring in ring-porous woods to produce a pronounced grain pattern.

**Planer Bite** A deeper than intended groove cut into the surface of a piece of wood by planer knives.

**Plank** Solid or Engineered/ boards 3" and wider designed to be installed in parallel rows.

**Plywood** Board or panel made of cross-directional veneers and/or layers of wood for dimensional stability.

**Plugs** Used to cover countersunk screws when installing wood flooring or for decorative purposes in wood flooring.

**Prefinished** Factory-finished flooring that only requires installation.

**Quartersawn** The annual growth rings of wood form an angle of 45° to 90° with the surface of the piece. In quartersawn strips, the medullary rays or pith rays in ring-porous woods are exposed as flecks that are reflective and produce a distinctive grain pattern.

**Raised Grain** A roughened or fuzzy condition of the face of the flooring in which the dense summerwood is raised above the softer springwood but not torn or separated.

**Rays, Wood** See Medullary Rays.

**Reducer Strip** A teardrop-shaped molding accessory for hardwood flooring, normally used at doorways, but sometimes at fireplaces and as a room divider. It is grooved on one edge and tapered or feathered on the other edge.

**Relative Humidity** Ratio of the amount of water vapor present in the air to that which the air would hold at saturation at the same temperature. It is usually considered on the basis of the weight of the vapor, but for accuracy should be considered on the basis of vapor pressures.

**Rift Sawn** Lumber (primarily hardwoods) in which the annual rings make angles of 30° to 60° with the surface of the piece. Also known as bastard sawn.

**Ring-Porous Woods** A group of hardwoods in which the pores are comparatively large at the beginning of each annual growth ring and decrease in size, more or less abruptly, toward the outer portion of the annual growth ring. The large pores are springwood and the smaller pores are summerwood.

**Ring Shank** Nail Headed nail for underlayment installation with rings on the shaft (shank) to improve the holding characteristics.

**S4S (Surface-4-Sides)** Flooring that isn't tongue-and-grooved. May also refer to square-edge strip flooring that is face-nailed when installed.

**Sapwood** The wood near the outside of a tree. It is usually lighter in color than heartwood.

**Sawn** See Plain Sawn, Quartersawn and Rift Sawn.

**Screed** A wood member laid perpendicular to the finished floor, providing a nailing surface.

Usually a 2-by-4 inch (50MM by 100MM) piece of wood laid flat side down and attached to a concrete subfloor to provide a nailing surface for tongue-and-groove strip flooring or a wood subfloor.

**Shake** A separation along the grain, the greater part of which occurs between the annual growth rings.

**Sheathing** The structural covering, usually sheets of plywood, placed over exterior studding, or rafters or subfloor of a structure.

**Side-Matched** In tongue-and-groove strip and plank flooring, the individual pieces have a tongue milled on one side and a groove milled on the opposite side, so that when the individual strips or planks are placed side by side, the tongue of one piece fits into the groove of the next piece. See End-Matched and Tongue-and Groove.

**Slats** See Fillets.

**Sleeper** Another name for screeds.

**Slip-Tongue/Spline** A small strip of wood or metal used to reverse or change direction in installing standard tongue-and-groove strip flooring.

**Softwoods** General term used to describe lumber produced from needle and/or cone-bearing trees (conifers).

**Solid Board Group 1** A designation of a certain species based on density, strength and stiffness.

**Split** Separations of wood fiber running parallel to the grain.

**Square Edge** Flooring that abuts without a broken plane.

**Squares** Parquet flooring units, usually composed of an equal number of slats.

**Streaks** See Mineral Streaks.

**Strip Flooring** Solid or engineered boards, less than 3 inches in width, to be installed in parallel rows, produced in various thicknesses and widths. The strips are side-matched and end-matched (tongue-and-grooved). They are for nail-down installation directly to wood or plywood subfloors, or over wood screeds on concrete slab construction. Some types can also be glued directly to a concrete subfloor.

**Surface** The outside or exterior boundary of any substance. One is said to surface the work when it is rubbed or sanded to a smooth, level plane.

**Tongue-and-Groove** In strip, plank and parquet flooring, a tongue is milled on one edge and a groove cut on the opposite edge. As the flooring is installed, the tongue of each strip or unit is engaged with the groove of the adjacent strip or unit. See End-Matched and Side-Matched.

**Trim** The finish materials in a building at the floor of rooms, (baseboard, base shoe, quarter round for example).

**Trowel Fill** Method to fill an entire floor or large area.

**Truss** Engineered or solid floor joist system.

**Unfinished** A product that must have stain and/or a finish applied after installation.

**Vapor Impermeable Membrane** A material or covering having a permeance rating of .15 perms or less when tested in accordance with the desiccant method, Procedure A of ASTM E-96. A vapor impermeable membrane limits the passage of moisture to near 0, or almost none.

**Vapor Permeable Membrane** A material or covering having a permeance rating of 5 perms or greater when tested in accordance with the desiccant method, Procedure A of ASTM E-96. A vapor permeable membrane permits the passage of moisture.

**Vapor Retarder** A vapor-resistant material, membrane or covering such as foil, plastic sheeting or covering having a permeance rating of 1 perm or less, when tested in accordance with the desiccant method, Procedure A of ASTM E-96. Vapor retarders limit the amount of moisture vapor that passes through a material, or floor, wall or ceiling assembly.

**Warping** Any distortion of a piece of flooring from its true plane that may occur in seasoning.

**Working Pressure** The pneumatic pressure range specified in pounds per square inch (PSI) to optimally run an air tool. (See tool manufacturer's guidelines.) Note that these air pressures should be metered at the tool